

flrig\_help

2.0.04

Generated by Doxygen 1.9.1



<b>1 flrig_help_2.0.04</b>	<b>1</b>
<b>2 Contents</b>	<b>3</b>
2.1 Contents . . . . .	3
<b>3 Initial Setup</b>	<b>5</b>
3.1 Xcvr Select . . . . .	6
3.1.1 Configure PTT . . . . .	6
3.1.2 Configure CMEDIA PTT . . . . .	7
3.1.3 Configure TCPIP & TCI . . . . .	8
3.1.4 Use Pi GPIO PTT . . . . .	8
3.1.5 Configure other auxiliary ports . . . . .	11
3.1.6 Configure Polling . . . . .	11
3.2 Config Data Files . . . . .	12
<b>4 Configure Read/Restore Xcvr Settings</b>	<b>13</b>
<b>5 Additional Controls</b>	<b>15</b>
<b>6 Configure User Interface</b>	<b>17</b>
6.0.1 Meter Display and Filters . . . . .	18
6.0.2 Slider sizing . . . . .	19
<b>7 User Interface Styles</b>	<b>21</b>
7.1 Transceiver Control . . . . .	21
7.2 Select Interface . . . . .	23
<b>8 Main Dialog Controls</b>	<b>25</b>
8.1 Frequency Controls . . . . .	25
<b>9 Memory Dialog</b>	<b>29</b>
<b>10 CW Keyer</b>	<b>31</b>
10.1 CW Keyer . . . . .	31
<b>11 FSK Keyer</b>	<b>35</b>
<b>12 User-Defined Commands</b>	<b>37</b>
12.0.1 Send Command String . . . . .	38
<b>13 Controlling Multiple Transceivers</b>	<b>39</b>
<b>14 Configure XmIRpc Server</b>	<b>41</b>
14.1 flrig XmIRpc Command Structures . . . . .	41
<b>15 Remote flrig</b>	<b>45</b>
15.1 Remote Flrig Server . . . . .	45
15.2 Remote Client . . . . .	46

---

<b>16 Program Debugging</b>	<b>49</b>
16.1 Event Log . . . . .	49
16.2 Tracing Program Execution . . . . .	49
<b>17 Supported Transceivers</b>	<b>51</b>
17.1 Transceiver Setup Examples . . . . .	52
<b>18 Supported Elecraft Transceivers</b>	<b>53</b>
<b>19 Supported ICom Transceivers</b>	<b>57</b>
<b>20 Supported Kenwood Transceivers</b>	<b>69</b>
<b>21 Supported TenTec Transceivers</b>	<b>75</b>
<b>22 Supported Yaesu Transceivers</b>	<b>79</b>
<b>23 Other Supported Transceivers</b>	<b>89</b>
<b>24 FT-991A setup</b>	<b>95</b>
24.1 Transceiver setup . . . . .	95
24.1.1 FT-991A Menu Settings . . . . .	95
24.1.2 Initial Setup . . . . .	96
24.1.3 Select the Serial Port to use: . . . . .	97
24.1.4 Restore tab: . . . . .	97
24.1.5 Poll tab . . . . .	98
24.2 flrig/FT991A/flidigi . . . . .	98
24.2.1 Final Setup . . . . .	99
<b>25 IC-7100 Setup</b>	<b>101</b>
25.1 IC 7100 menu setup . . . . .	101
25.2 flrig setup . . . . .	102
25.2.1 Install flrig. . . . .	102
25.2.2 Restore xcvr parameters . . . . .	103
25.2.3 Select the Poll tab . . . . .	104
<b>26 IC-7300 Setup</b>	<b>105</b>
26.1 IC 7300 menu setup . . . . .	105
26.2 flrig setup . . . . .	106
26.2.1 Install flrig. . . . .	106
26.2.2 Restore xcvr parameters . . . . .	107
26.2.3 Select the Poll tab . . . . .	108
<b>27 IC-7600 Setup</b>	<b>109</b>
27.1 IC-7600 SETTINGS . . . . .	109
27.2 SOFTWARE SETTINGS . . . . .	110

---

27.2.1 FLDIGI . . . . .	110
27.2.2 FLRIG . . . . .	110
27.2.3 SETTING LEVELS AND TUNING . . . . .	111
<b>28 TT550 - Pegasus</b>	<b>113</b>
28.1 Additional Control . . . . .	114
28.1.1 CW . . . . .	115
28.1.2 VOX . . . . .	115
28.1.3 Speech . . . . .	115
28.1.4 Audio . . . . .	116
28.1.5 RX . . . . .	116
28.1.6 TX . . . . .	116
28.1.7 302A . . . . .	117
<b>29 Prefs file contents</b>	<b>119</b>



# Chapter 1

## flrig\_help\_2.0.04

FLRIG is a transceiver control program designed to be used either stand alone or as an adjunct to FLDIGI and other 3rd party programs such as wsjtx. The supported transceivers all have some degree of CAT.

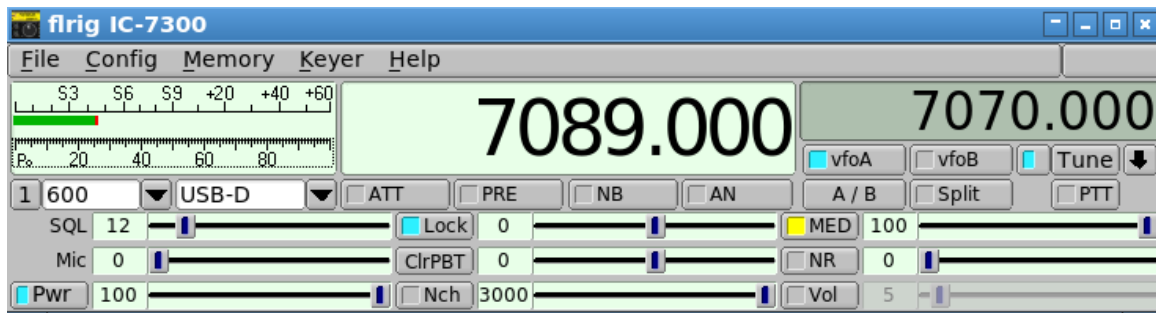

[Contents](#)





# Chapter 2

## Contents

### 2.1 Contents

1. [Initial Setup](#)
2. [Configure Read/Restore Xvcr Settings](#)
3. [Additional Controls](#)
4. [Configure User Interface](#)
5. [User Interface Styles](#)
6. [Main Dialog Controls](#)
7. [Memory Dialog](#)
8. [CW Keyer](#)
9. [FSK Keyer](#)
10. [User-Defined Commands](#)
11. [Controlling Multiple Transceivers](#)
12. [Configure XmlRpc Server](#)
13. [Remote Flrig Server](#)
14. [Program Debugging](#)
15. [Supported Transceivers](#)



## Chapter 3

# Initial Setup

Select the transceiver with the "Config / Setup / Transceiver" menu item.

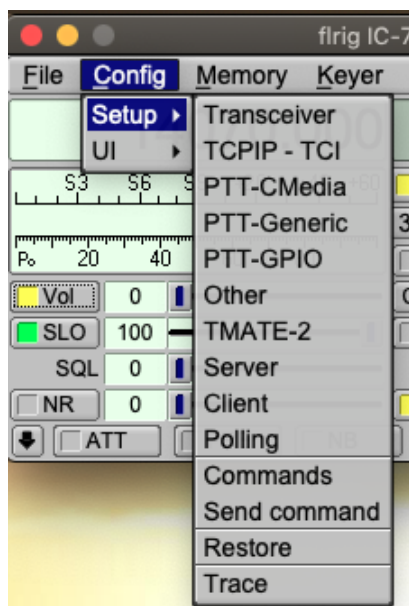

Each of the menu items will open the configuration dialog to the respective tab:

- **Transceiver** - select transceiver and configure serial i/o parameters
- **TCPIP - TCI** - configure interface to a remote tcpip/serial controlled transceiver
- **PTT - CMedia** - configure PTT using Cmedia codec pin 13
- **PTT - Generic** - configure PTT using serial port CAT, DTR or RTS
- **PTT - GPIO** - configure PTT using GPIO port, Pi hardware platform
- **Other** - configure separate auxiliary serial ports (if used)
- **TMATE-2** - setup the TMATE-2 interface
- **Server** - change XmlRpc server port designation
- **Client** - address of the server this client will connect to

- **Polling** - select and configure transceiver parameters to poll
- **Commands** - add/delete/modify user created CAT commands
- **Send command** - edit/send single CAT command
- **Restore** - select and configure transceiver parameters to read and restore
- **Trace** - select and display program execution paths

### 3.1 Xcvr Select

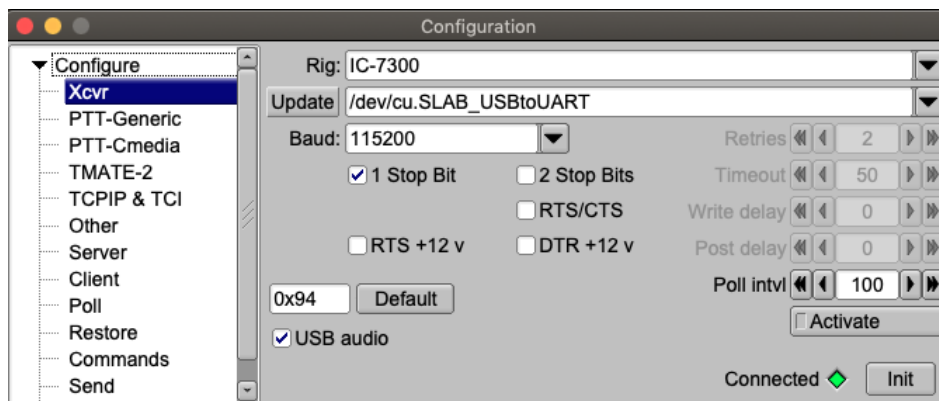

Figure 3.1 I/O Ports - Xcvr

Select the rig in use from the "Rig" combo box.

The default values associated with that transceiver will be preset for you. These have been verified by the test team but might require some tweaking for your particular h/w.

If required by the hardware interface, set either RTS or DTR to +12 if interface power is derived from the serial port.

#### 3.1.1 Configure PTT

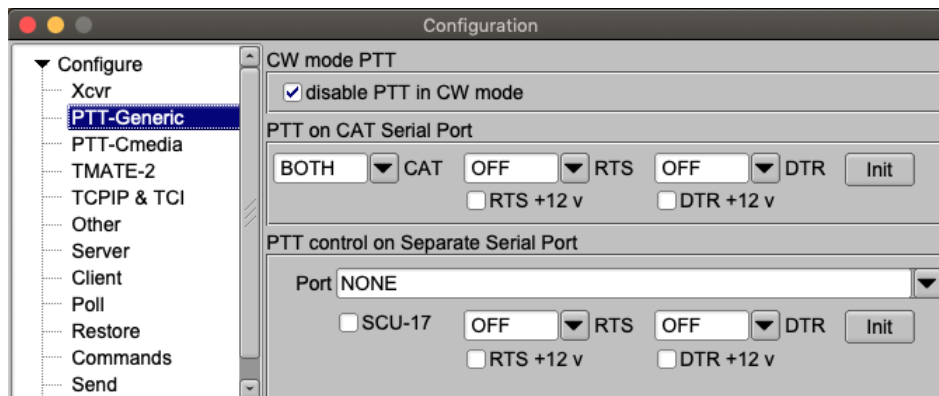

Figure 3.2 I/O Ports - PTT

Select CAT PTT if your transceiver supports a CAT command for PTT on/off. This control will default to checked if CAT PTT is supported.

You may prefer to use h/w PTT signaling instead of CAT PTT. The h/w PTT may be shared with the CAT serial port. Note that both RTS/CTS handshake and RTS PTT cannot both be used on a single serial port.

Your PTT h/w control may also make use of a second serial port. If that port is the secondary serial port of the SCU-17 then you must also enable the "Serial Port is SCU-17 auxiliary" control.

### 3.1.2 Configure CMEDIA PTT

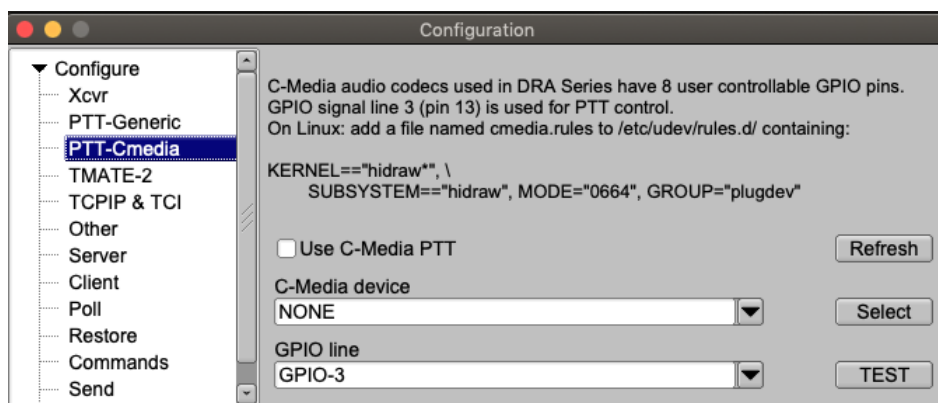

Figure 3.3 Cmedia PTT control

Cmedia audio codec chips are used in a number of inexpensive USB audio thumbnail devices.

It is also used in the DRA@ series of sound card adapters. The DRA is a radio optimized sound card used to connect a two-way radio to a computer for digital communications. The DRA-Series digital radio adapter is used for Packet Radio or other digital programs and applications like VARA-FM, VARA-HF, SoundModem or fldigi.

All RA Series radio adapters include GPIO support. The Cmedia device supports 4 unbuffered input/output lines, GPIO-1 ... GPIO4. GPIO-3 is used to drive a fully buffered and deadman protected PTT circuit. All DRA Series radio adapters include a Heartbeat Monitor. When the Cmedia device is reading or writing audio data, the Heartbeat status LED (HB) will be flashing. If everything is okay, (HB LED is flashing) a Blue LED called "COMM OK" illuminates. If the HB LED stops flashing because the radio adapter or the computer/appliance has failed, or the software has stopped reading or writing audio data, the Blue COMM OK LED goes out. The Blue LED indicates the health status of the system, and illuminates when everything is okay.

The PTT line on any DRA Series radio adapter is interrupted with the failure of this health status. This function will kill the PTT line the audio stream is interrupted. This will occur if fldigi and similar modem program is not reading/writing audio data.

The circuitry was designed to operate correctly no matter if the Heartbeat has stuck in the on or off state.

The PTT type, the device and the GPIO line must be selected. If multiple C-Media devices are discovered they will enumerate as C-Media-A, C-Media-B, etc.

You must test the selected interface as it is not possible to know which is the correct one for the DRA interface. Pressing the TEST button will cause the PTT line to rapidly toggle for a period of 2 seconds. This will cause the RED PTT led to flash and the transceiver PTT to toggle on and off.

### 3.1.3 Configure TCPIP & TCI

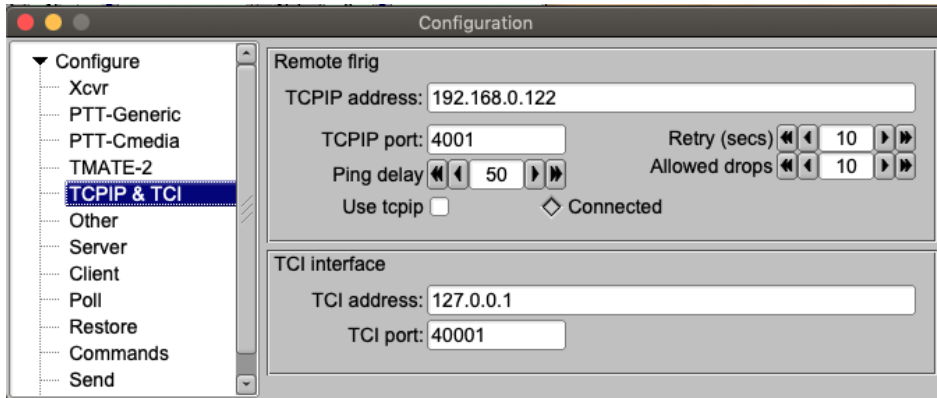

Figure 3.4 Remote Frig Setup

#### TCPIP

flrig is can communicate with a transceiver that provides CAT control over ethernet. It can also communicate with a remote computer with a software serial to ethernet converter such as SOCAT. Both the device address and port must be specified.

#### TCI

Transceiver Control Interface was developed by Expert Electronics company, for advanced connection between the ExpertSDR2 and third-party software. TCI has all required control commands similar to CAT system, but even more, it can transfer IQ-streams from the ExpertSDR2 to client applications. The ExpertSDR2 is the only TCI capable transceiver.

### 3.1.4 Use Pi GPIO PTT

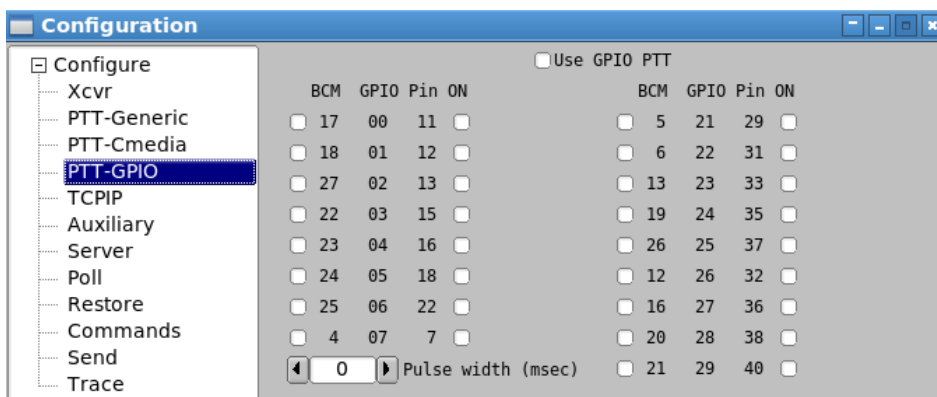

Figure 3.5 GPIO PTT control

The Pi series of miniature computers offer a large array of possibilities for controlling devices. It has a array of General Purpose Input Output, gpio, lines of a 40 pin in-line header. 17 of these gpio lines can be used for things like push-to-talk. There are several add on boards for the Pi3 and Pi4, such as the NW Digital Radio UDRC-II, that has a full interface for digital operations, including PTT and audio codecs.

Access to hardware ports is always limited to the user who either is root or has root privileges. `setuid` and `setgid` (short for set user ID upon execution, and set group ID upon execution, respectively) are Linux access rights flags that allow users to run an executable with the permissions of the executable's owner or group respectively and to change behaviour in directories. They are often used to allow users on a computer system to run programs with temporarily elevated privileges in order to perform a specific task. While the assumed user id or group id privileges provided are not always elevated, at a minimum they are specific.

It is possible to give full gpio access and control privileges by elevating flrig with `setuid root`. But this is not advisable as flrig is also granted access to both serial and network services. There is a way to provide the access via a second program that does have the elevated privilege

This is a copy of material at

```
https://projects.drogon.net/raspberry-pi/wiringpi/download-and-install/
```

for installing WiringPi which includes a really nice utility called `gpio`.

To obtain WiringPi using GIT:

```
$ git clone git://git.drogon.net/wiringPi
```

If you have already used the clone operation for the first time, then

```
$ cd wiringPi
$ git pull origin
```

Will fetch an updated version then you can re-run the build script below.

To build/install there is a simplified script:

```
$ cd wiringPi
$ ./build
```

The build script will compile and install it all for you. It does use the `sudo` command at one point, so you may wish to inspect the script before running it.

### Test wiringPi's installation

run the `gpio` command to check the installation:

```
$ gpio -v
$ gpio readall
```

That should give you some confidence that it's working OK.

WiringPi is released under the GNU Lesser Public License version 3.

flrig uses the `gpio` program for initializing the gpio port, which also happens to the change the privilege of the temporary sys file for setting the port state.

### Read the man document for `gpio`

GPIO is a swiss army knife of a command line tool to allow the user easy access to the GPIO pins on the Raspberry Pi and the SPI A/D and D/A converters on the Gertboard. It's designed for simple testing and diagnostic purposes, but can be used in shell scripts for general if somewhat slow control of the GPIO pins.

It can also control the IO's on the PiFace IO board and load the SPI and I2C kernel modules if required.

Additionally, it can be used to set the exports in the `/sys/class/gpio` system directory to allow subsequent programs to use the `/sys/class/gpio` interface without needing to be run as root."

After installing `gpio` on your Pi you can set the `gpio` port on flrig's GPIO configuration tab. The UDRC-II for example uses pin 16, BCM # 23, for push to talk. It has an LED indicator on the board to show when PTT has been enabled. For this board you select "BCM 23" and select the corresponding "= 1 (on)" check box.

During start up flrig uses the `gpio` program to set up the `gpio` pins with the command

```
$ gpio export NN out
```

This is the command to export a GPIO pin in the `/sys/class/gpio` directory. Note that the pin number is the BCM\_↔ GPIO number. 'out' sets the pin to be an output control, and 'in' an input control.

Once a GPIO pin has been exported, the `gpio` program changes the ownership of the

```
/sys/class/gpiogpioX/value
```

and if present in later kernels, the

```
/sys/class/gpio/gpioX/edge
```

pseudo files to that of the user running the `gpio` program. This means that you can have a small script of `gpio` exports to setup the `gpio` pins as your program requires without the need to run anything as root, or with the `sudo` command.

During shutdown flrig uses the `gpio` program to disable access to the `gpio` pins used with PTT by invoking the command

```
gpio unexport NN.
```

You can check that this is working correctly from a terminal window using the command

```
$ gpio readall
```



### 3.1.5 Configure other auxiliary ports

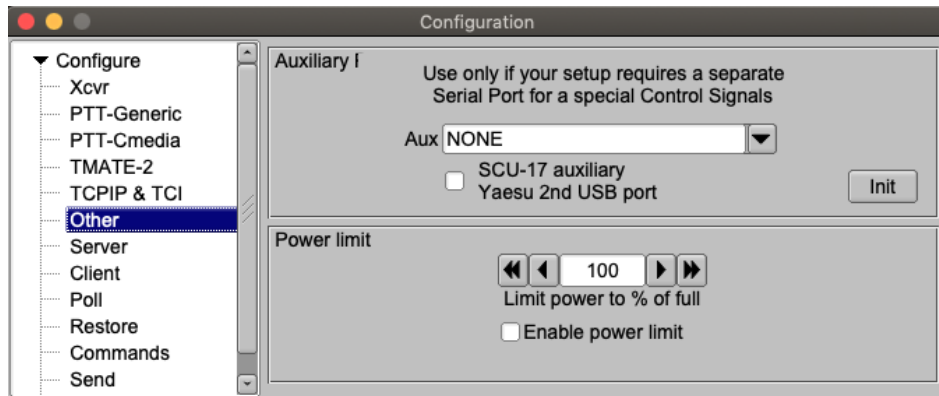

Figure 3.6 I/O Ports - Other



Figure 3.7 Aux Controls

You might also need access to special h/w functions. FLRIG provides this via the DTR and RTS signal lines of an independent serial port. Additional main dialog controls are enabled and shown if you select anything other than NONE (the default). Enable the "Serial Port is SCU-17 auxiliary" if you are using the SCU-17 secondary serial port.

Also on this same page a transmit power out limit may be set if your radio supports that feature. To activate it just set the desired power level and check the enable box.

### 3.1.6 Configure Polling

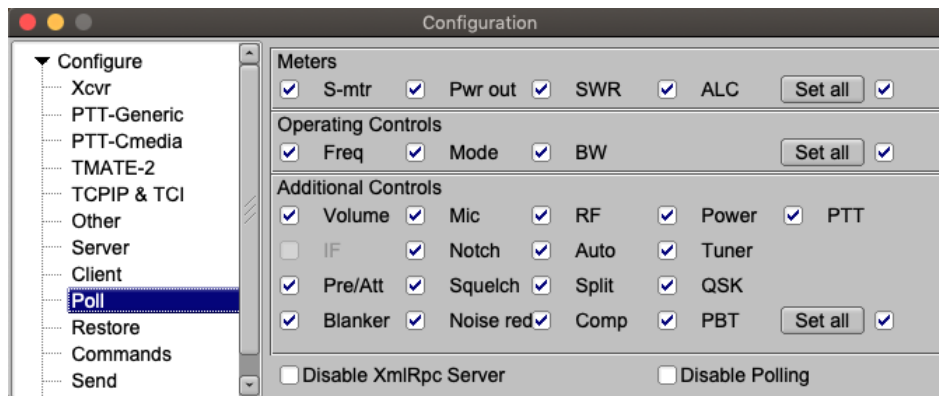

Figure 3.8 I/O Ports - Polling

Providing your transceiver supports the various meters and controls, you can elect to poll these every time the poll cycle occurs. Polling a value causes FLRIG to follow as well as control a particular transceiver function or control. The polling cycle will slow down as you elect to poll more and more values.

## 3.2 Config Data Files

Configuration and data files used by flrig consist of the following:

OS	Folder	File	Usage
Windows XP	c:\Documents and Settings\user-name\flrig.files	flrig.prefs	names transceiver file & xmlrpc port
Windows XP	c:\Documents and Settings\user-name\flrig.files	IC-7100.prefs (1)(2)	IC-7100 specific configuration items
Windows XP	c:\Documents and Settings\user-name\flrig.files	IC-7100.mat (1)(2)	IC-7100 specific memory file
Windows 7/8/10	c:\Users\user-name\flrig.files	flrig.prefs	names transceiver file & xmlrpc port
Windows 7/8/10	c:\Users\user-name\flrig.files	IC-7100.prefs (1)(2)	names transceiver file & xmlrpc port
Windows 7/8/10	c:\Users\user-name\flrig.files	IC-7100.mat (1)(2)	names transceiver file & xmlrpc port
Linux/Unix/OS-X	\$HOME/.flrig	flrig.prefs	names transceiver file & xmlrpc port
Linux/Unix/OS-X	\$HOME/.flrig	IC-7100.prefs (1)(2)	names transceiver file & xmlrpc port
Linux/Unix/OS-X	\$HOME/.flrig	IC-7100.mat (1)(2)	names transceiver file & xmlrpc port

(1) Several TRANSCEIVER.prefs and mat files may be in the folder. Each specific to the configured transceiver

(2) Files such as IC-7100.prefs.1, IC-7100.mat.1, up to a prefix of 5 may appear in the folder. These are aged files, with the oldest file having the largest prefix value. The mat files are only created if the user actually saved items to memory.

Transceiver Prefs details are shown in this file: [Prefs file contents](#).

The file is human readable. Editing the file is not recommended.

[Return to Contents](#)

## Chapter 4

# Configure Read/Restore Xvcr Settings

Frig will read various transceiver parameters and restore them upon closing. The next image shows the available read/restore parameters for the Icom 7200. If a parameter is not available (or coded) it will be disabled and grayed out. Check each parameter that you want to read and restore. Reading and restoring transceiver parameters takes time, especially on older transceivers with low baud rate serial i/o. Check "Use xcvr data" if you want frig to NOT change the transceiver operating state when it begins execution.

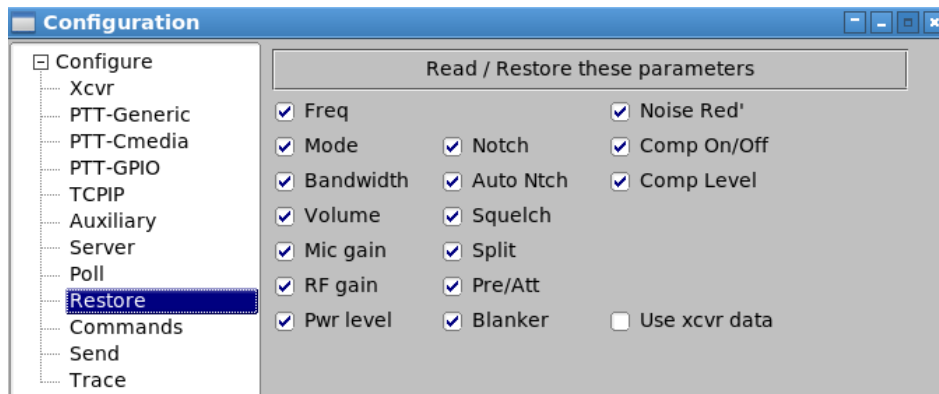

Figure 4.1 Restoring transceiver Status

[Return to Contents](#)



## Chapter 5

# Additional Controls

Additional control settings may be available depending on the transceiver being controlled. These are in a drop-down area toggled by the arrow button to the left of the attenuator button on the small aspect ratio dialog view. These are the controls for the Yaesu FT-710.

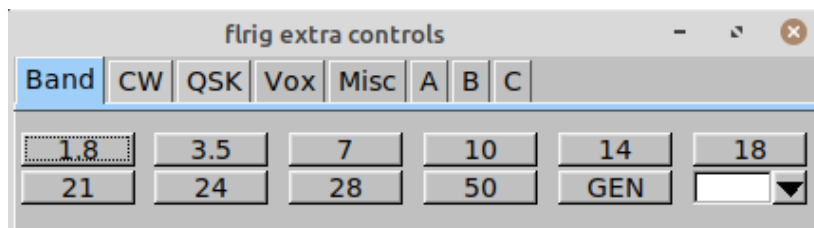

Left-click on a Band button to QSY to that band. Typically this will apply the settings saved in the top register in your rig's Band Stacking Registers for that band, if your rig supports BSR. This should provide similar functionality to physically pressing the rig's Band button. For example, on an Icom IC-7610, this will recall the frequency, mode, filter selection, and if FM mode, the tone frequencies last used on the selected band.

Additionally, if your rig supports the functionality, right-clicking on a Band button will store current values in the top register for that Band. You must right-click on the Band you are currently on. Most, if not all, rigs will reject attempts to set frequency values outside of the ham band limits in the BSR for a given band.

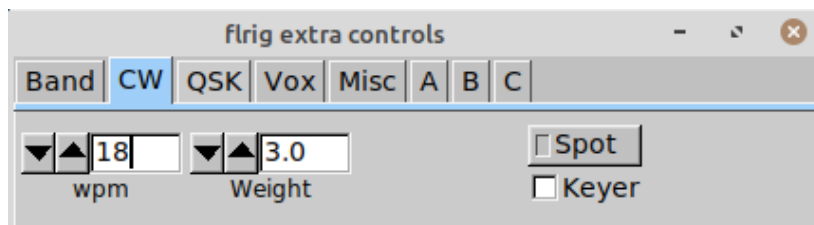

The CW tab is pretty well self explanatory. Set the WPM as desired. Weight refers to the ratio of Dit to Dash, but is not available on all rigs. What other controls are visible will depend on the rig being used.

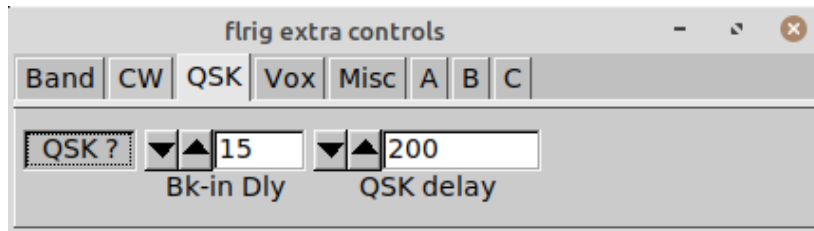

The QSK tab allows you to select Semi-breakin or Full-breakin with the QSK button. Bk-in Dly sets the time delay during Semi-breakin operation so the rig does not return to receive while keying. QSK delay does the same thing during Full-breakin operation.

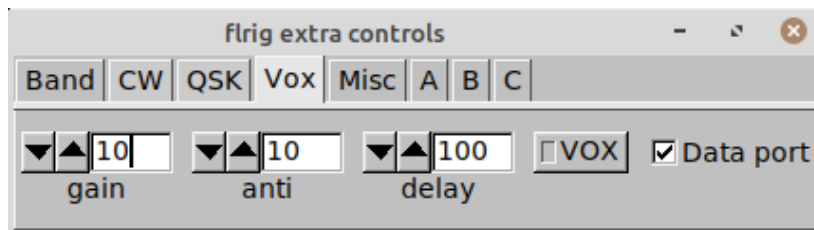

**Gain** refers to the sensitivity to your voice causing it to switch to transmit.

**Anti** refers to the Anti-Vox function of reducing the sensitivity to speaker or other noises so the rig will not go into transmit unintentionally.

**Delay** refers to the transmit-receive delay after cessation of speech.

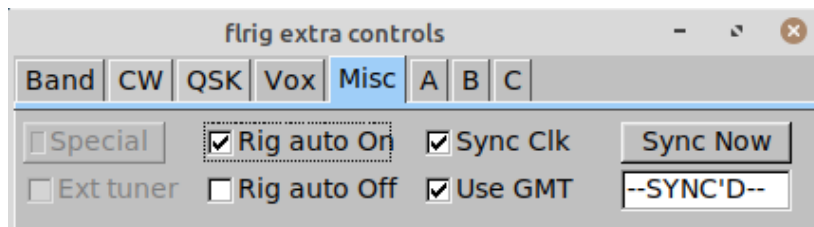

For those rigs with CAT controlled Power On/Off available set it as desired. Auto-on activates when flrig is first started. Auto-off activates as flrig shuts down. If the computer has CAT controlled time setting available flrig can set the rig's internal clock to the computer's time/date. This happens on the exact minute so you will see it showing the time until it has synchronized.

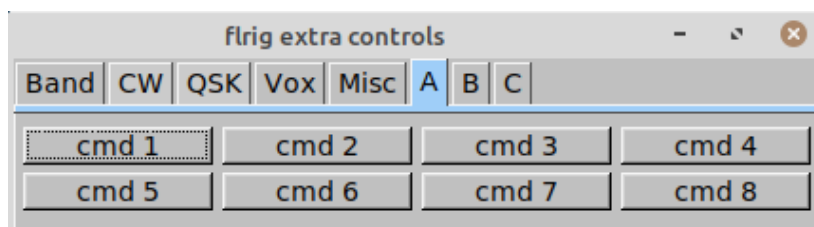

The A, B, and C tabs are 3 sets of 16 entries that can be CAT commands to perform functions that flrig does not have coded for your radio. Things like setting audio output level or any other functions that can be CAT controlled. Entries are setup via the flrig Config/Setup/Commands tab. See Chapter 10, User-Defined Commands, in this document.

[Return to Contents](#)

# Chapter 6

## Configure User Interface

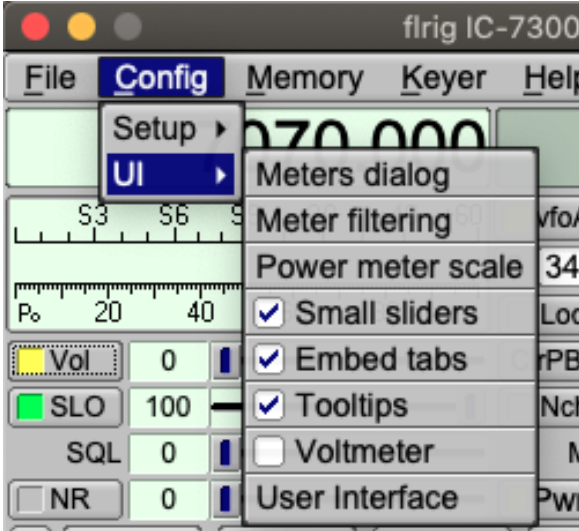

### 6.0.1 Meter Display and Filters

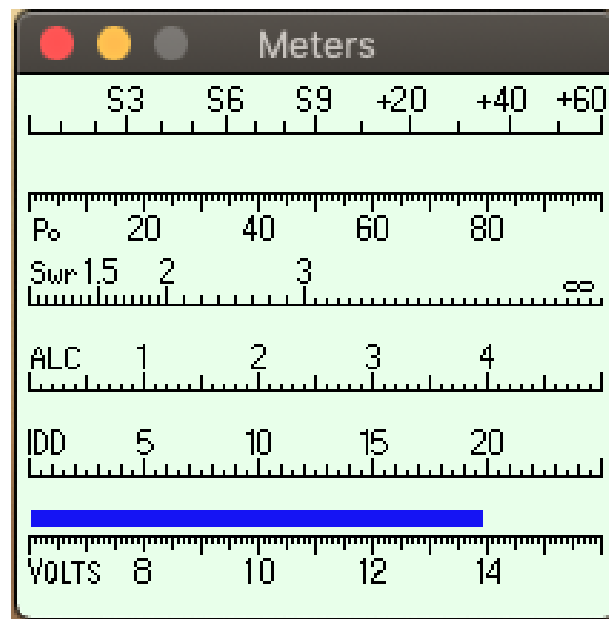

Figure 6.1 Meters Dialog

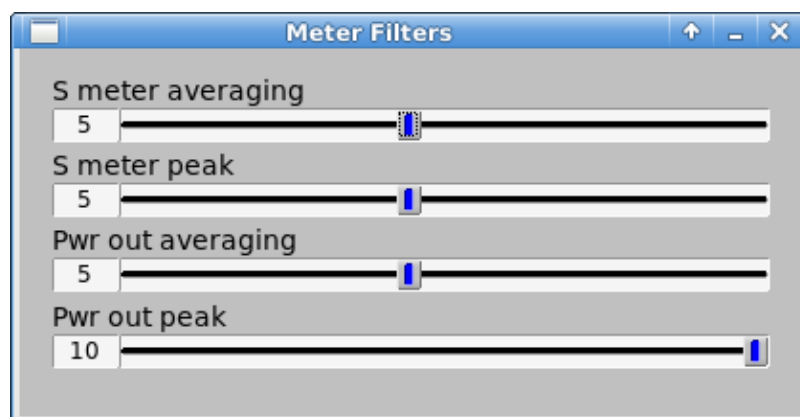

Figure 6.2 Meter Filter Controls

You can control the behavior of both the average and peak values of the S-meter and Power out meters. Setting the controls to 1 for both average and peak will simply display the latest value available from the transceiver. The average setting results in the display showing the average of the last N readings. The peak value will display the average peak value over the last M readings.



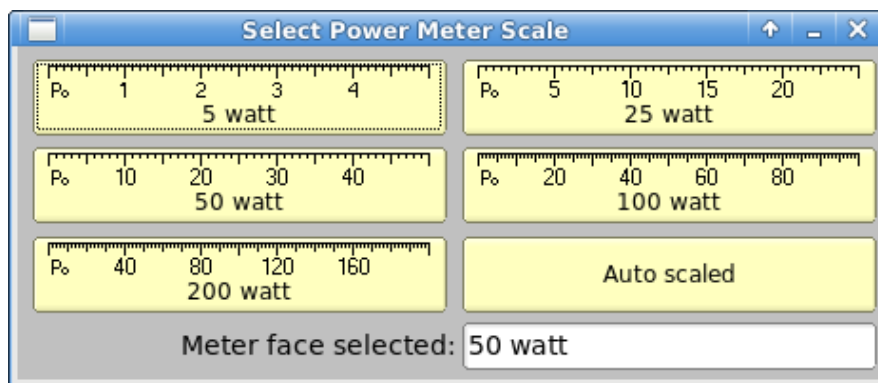

Figure 6.3 Meter Scale

Right click on the main dialog power meter scale to open up this selection dialog. Each of the 4 scales and the "Auto scaled" box are buttons. Press the one you want to use. Auto-scaling adjusts the meter scale to the smallest scale consistent with the current measured peak power. If that power is fluctuating near the transition point between two scales you might want to fix the scale to either the larger or smaller.

## 6.0.2 Slider sizing

When the user interface is configured to be "small" then the UI submenu will contain the item "Small sliders". Toggling this menu item will immediately change the size and positions of the various slider controls. Select the toggle button "Small sliders" on the Config menu for 1/2 size sliders and a dialog layout that uses less vertical space.

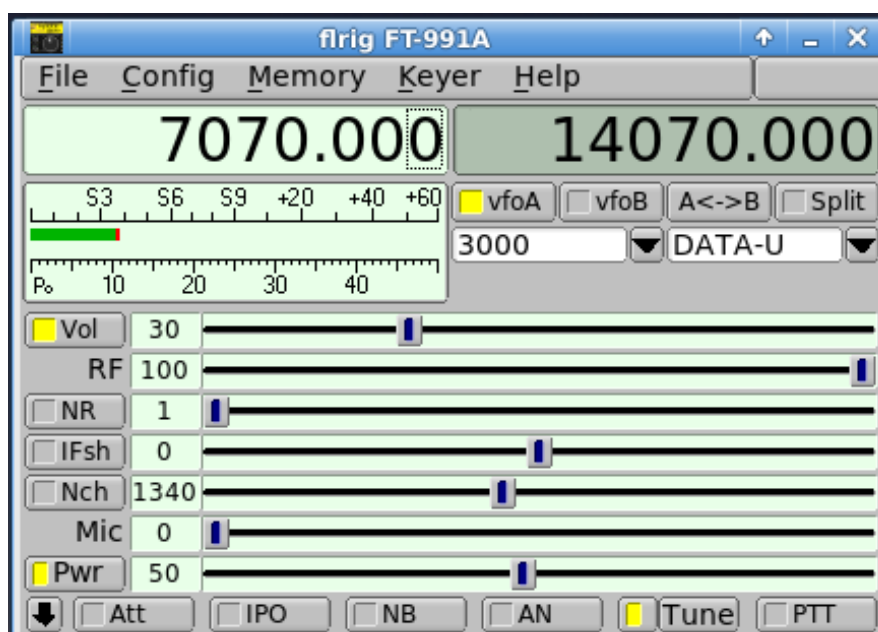

Figure 6.4 Small UI - Large Sliders

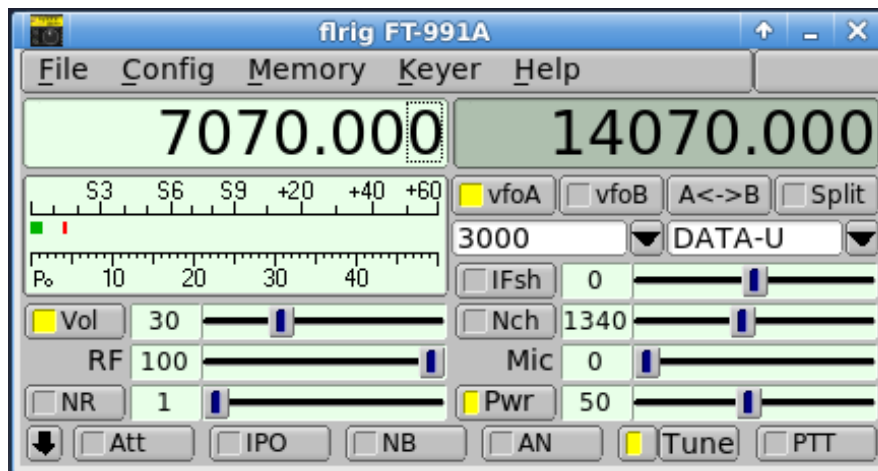

Figure 6.5 Small UI - Small Sliders

[Return to Contents](#)

## Chapter 7

# User Interface Styles

### 7.1 Transceiver Control

The FLRIG user interface changes to accommodate the degree of CAT support available for the transceiver in use.

Three different main dialog aspect ratios can be selected to suit the computer screen dimensions and operator preferences. The wide aspect ratio can be resized horizontally. The narrow aspect ratios are fixed in width and height.

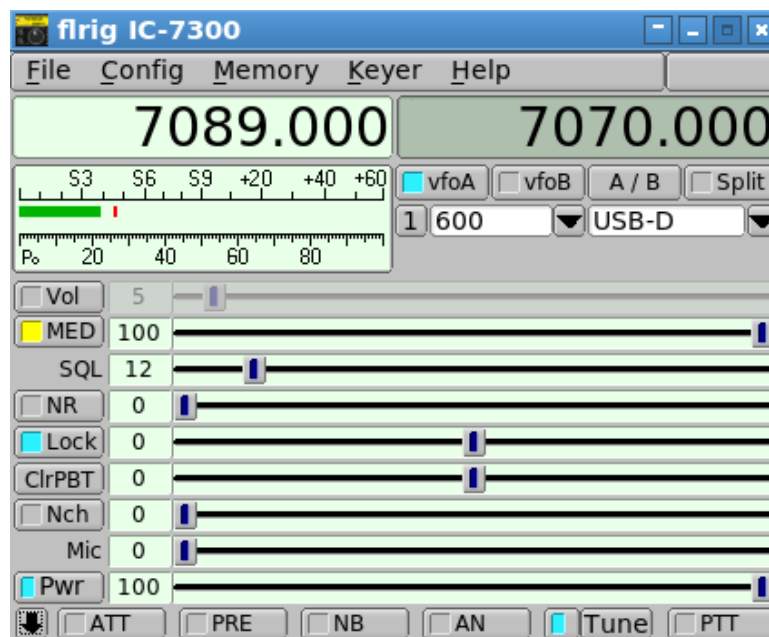

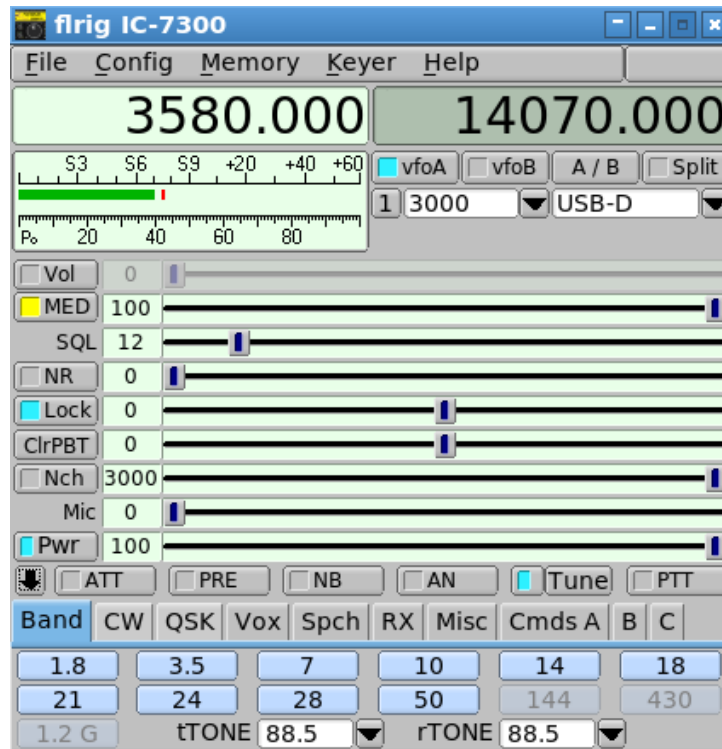

Figure 7.1 With embedded extras tab

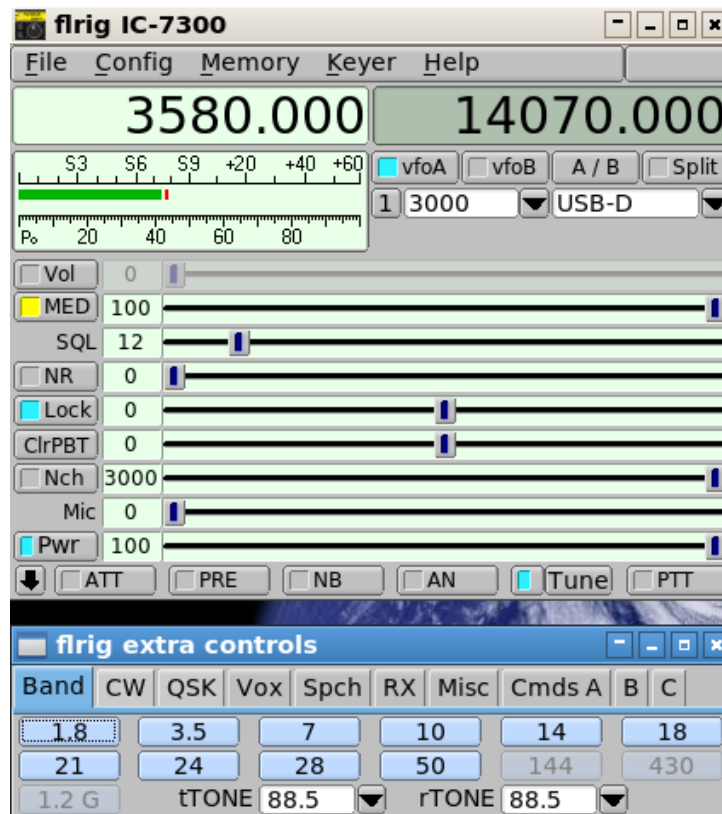
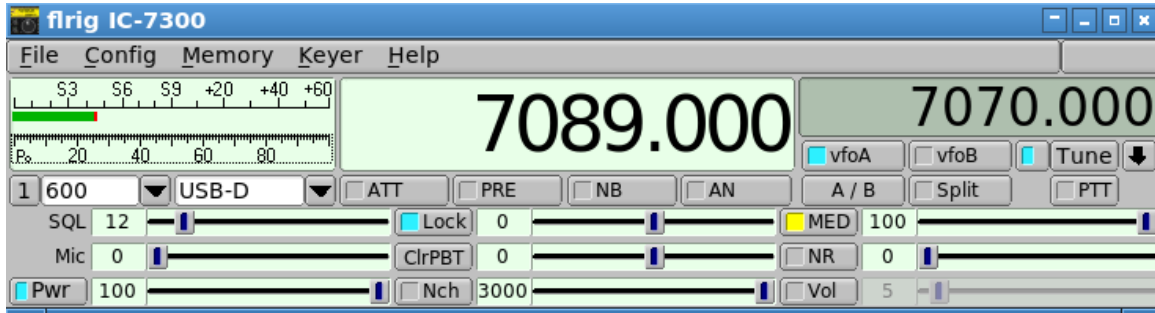

Figure 7.2 Separate extras tab dialog



A fourth interface is available for all transceivers. It is suitable for use on a touch screen

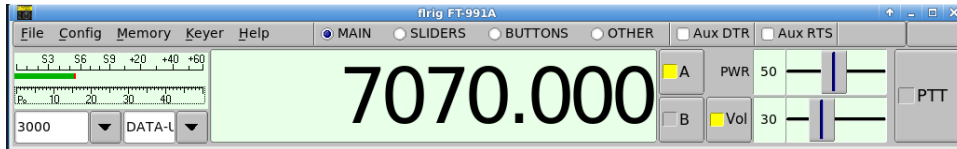
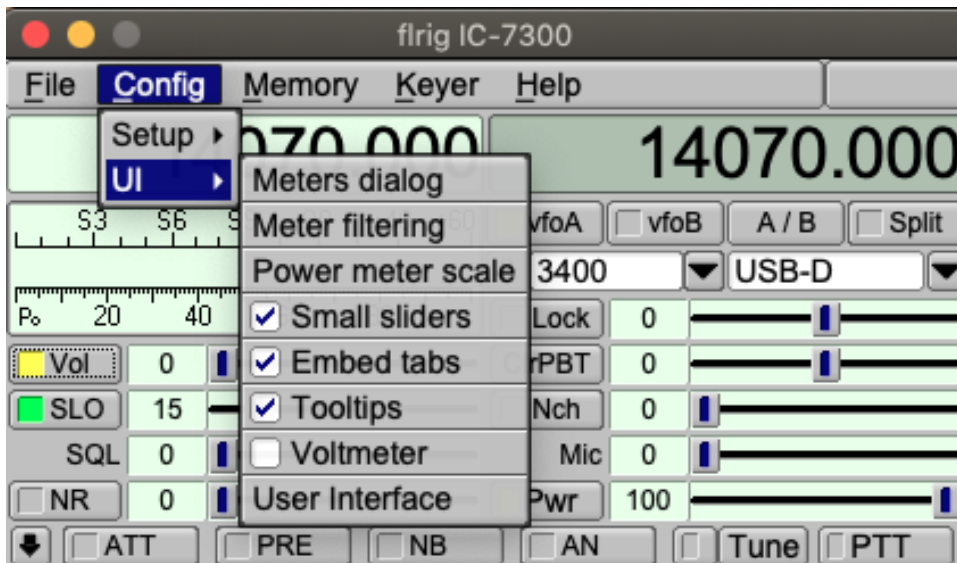
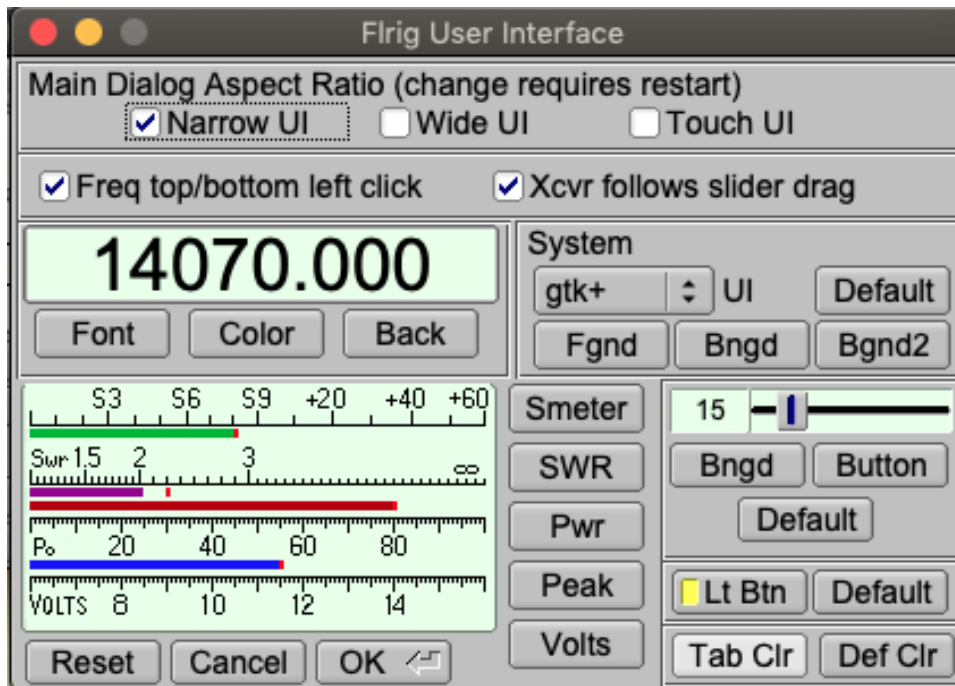

Figure 7.3 Shown at 75% of full size

## 7.2 Select Interface





Many details regarding the user interface can be customized via selections with this dialog.

Turning on "Tooltips" will be very helpful to understand what will change when an item is selected. Changes are shown immediately so the change is obvious.

"Freq. top/bottom left click" refers to changing the frequency via the mouse clicking on the frequency digits in the main display.

"Xcvr follows slider drag" refers to dragging the slider buttons on the flrig interface either changing as you drag or waiting to change until the dragging stops.

The font and size of the frequency display may be chosen via the Font, Color, Back(background) buttons. Note: Using fixed fonts usually gives better results.

The "System" group refers to different looks & feel of the main dialog. Try each and see which you prefer. Also the Fgnd, Bngd & Bgnd2 will affect those aspects of the main GUI.

Change the default meter indicator colors by clicking on the corresponding button.

The main interface slider backgrounds & button colors are changed via the buttons in that group.

In the group at the bottom right the "Lt Btn" button allows the changing of the "On" light color. The "Tab Clr" refers to the color of the additional controls tabs visible when you click the large down arrow in the main flrig display.

[Return to Contents](#)

## Chapter 8

# Main Dialog Controls

### 8.1 Frequency Controls

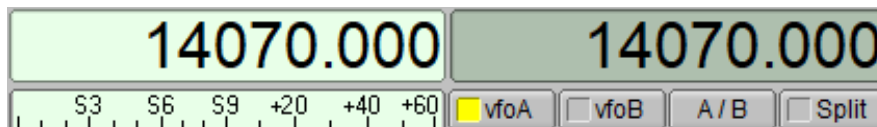

Figure 8.1 Frequency Control

The frequency display is also a control; it displays frequency in kHz. In addition to allowing you to set the rig frequency, it will track with changes made on the rig itself.

The number of digits that may be entered and the number of decimal digits displayed are determined by hard-coded data for the rig selected if using rig control. The intent is to match the actual rig display.

If you select NONE for rig control, 7 digits to the left of the decimal and 3 digits to the right are displayed.

In the rig control case, the maximum frequency is determined by the rig; in the NONE case, the maximum frequency is 9,999,999.999 kHz.

The maximum frequency **based on the number of digits displayed** is given in the tooltip. Note that this may be greater than the maximum frequency possible for your rig. If you attempt to set an unsupported frequency, the result depends on the rig.

You can set the frequency two ways without the control being in "focus" and several more ways with it in focus.

#### With or without Focus

- Move the mouse cursor over a digit and roll the wheel
- Highlight a numeric frequency in text in the application and then move the mouse cursor over the control and press the middle mouse button to paste selection

### With Focus

**Shift-Left-Click** (hold keyboard SHIFT button and press left mouse button) in the control to set focus. The foreground and background colors reverse to indicate the control has focus.

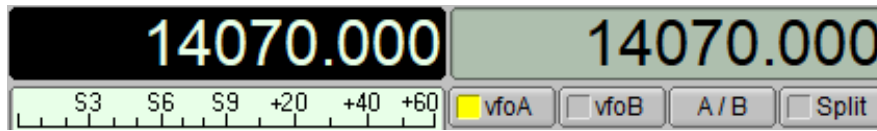

Figure 8.2 Frequency Control - vfoA has focus

Each digit is sensitive to the mouse. Clicking the left or right button over the top half of a digit increments it while clicking over the lower half decrements it. Holding the mouse button down will cause the number to rapidly increase or decrease. In all cases the numbers "roll over" - i.e., you can change the digit you point to and all digits to the left of it. **Be aware** that if you have chosen to uncheck the **Freq Top/Bottom left click** box in the User Interface dialog that the incrementing/decrementing reverts to left click increments and right click decrements the digit under the mouse pointer.

Arrow and Page Up / Page Down Keys can be used to increment and decrement digits. Digits are numbered 0-9, right to left, with the digit's significance matching that of the rig's display. For example, if the rig's resolution is 1 Hz, D0's range is 0-9 Hz.

Keys	Normal	SHIFT + key	CTRL + key
right / left arrow	+/- D0	+/- D1	+/- D2
up / down arrow	+/- D3	+/- D4	+/- D5
Page Up / Page Down	+/- D6	+/- D7	+/- D8

All of the foregoing change techniques result in immediate changes to the frequency of a controlled rig.

There are two additional ways to set the frequency when the control has focus: **PASTE from clipboard** and **direct keyboard entry**.

You can paste from the clipboard (Ctrl/Meta-v) in addition to from the Selection buffer (middle mouse button). When pasting from a selection (highlighted number), the selection must be from text within the application whereas the clipboard paste will paste values copied from any application. The value pasted is expected to be numeric in units of kHz and can include a decimal point. If the value being pasted would exceed the maximum frequency allowed, the Paste action is silently ignored. Paste actions result in an immediate command to set the frequency on a controlled rig.

Lastly, you may enter a frequency directly from the number keys or keypad of a keyboard. Enter the frequency in kHz, including decimal point if there are non-zero decimal components, using either the number keys or the keypad. You may use any legal floating point format. For example:

- 7070



- 14070.235
- 14.07e3 (Remember that the numeric value is in kHz so this example is 14070 kHz or 14.070 MHz)

When you press the first number, the decimal point in the display will blink to indicate you are in numeric entry mode. While in numeric entry mode, all other entry modes are disabled (i.e., no mouse clicks, rolls, or pastes are possible).

Continue to enter numbers, and optionally a decimal and more numbers. The value does NOT get sent to a controlled rig until you press the ENTER key. Pressing the ENTER key sends the value to the rig and exits the numeric entry mode.

If you want to make changes as you are entering numbers, you can use the backspace key to delete undesired numbers digit by digit, or Ctrl/Meta-Backspace to clear all digits on the side of the decimal point you are currently entering; use Ctrl/Meta-Backspace again to clear the left of decimal numbers as well if you have already entered a digit to the right of the decimal point, and then resume entering numbers.

If you attempt to enter more digits on either side of the decimal than there are digits available, the excess digit entries are ignored.

If you want to abort the process you can press the ESC (escape) key or click outside the control in a widget that will take focus (like a text field) or outside the application and the frequency will remain as it was; this exits numeric entry mode.

Vfo-A and Vfo-B are separate controls, A on the left, B on the right. If your radio has two VFOs, you can make one or the other active for transmission and reception by clicking on the corresponding button. Note that many radios allow you to change the frequency of an inactive VFO through remote command, in which case you do not have to click on the corresponding button to set its frequency.

Left click on the A/B button to swap several of the parameters of the VFOs (e.g., frequency, filter setting, mode) and change the active VFO to follow (so effectively your operation has not changed but you are using the other VFO).

Shift-click to copy just the frequency from Vfo-A to Vfo-B, and Ctrl-Click to copy in the other direction.

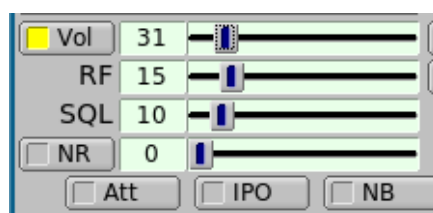

**Figure 8.3 Control Sliders**

The buttons that have a light box are toggles - activated when the lighted box is colored. Some of these are linked to a slider. If the button state is inactive then that associated slider will be greyed out. In the example the volume control is active and the NR control is inactive.

PTT can be activated at FLRIG or using the T/R button on FLDIGI. FLDIGI also engages the PTT via the macro <TX> <RX> tags. When operating digital modes with FLDIGI you should use the PTT from FLDIGI.

[Return to Contents](#)



## Chapter 9

# Memory Dialog

Operating frequency, mode, and bandwidth can be saved for later use. Save the current values to the memory file using the "Memory / Save" menu item. Open the memory manager using the "Memory / Manage" menu item

Add ▶	Frequency	BW	Mode	Comments
Pick ◀	7020.000	300	CW-U	40 CW
Del ✕	7070.000	3000	DATA-U	PSK sub band
Clr ■	7089.000	3000	DATA-U	Feld Hell net
Font				
Close				
Tag:	Feld Hell net			

The "Add", "Pick", "Del" and "Clr" buttons operate as labeled.

Note: When clicking the Add button the current contents of the active VFO will be entered sorted by frequency. To add a comment entry left click on a line to enable modifying the Tag line for that entry. Terminate the tag entry with the "Enter" key.

The contents of a typical transceiver .mat file contains:

```
020000 2 5 "40 CW"  
7070000 11 16 "PSK sub band"  
7089000 11 16 "Feld Hell net"
```

Each line contains a frequency (Hz), Mode Nr., Bandwidth Nr., and "text tag". The file contents are specific to a transceiver and are not meant to be shared other transceivers.

The file is human readable. Editing the file is not recommended.

[Return to Contents](#)



# Chapter 10

## CW Keyer

### 10.1 CW Keyer

Open the keyer dialog

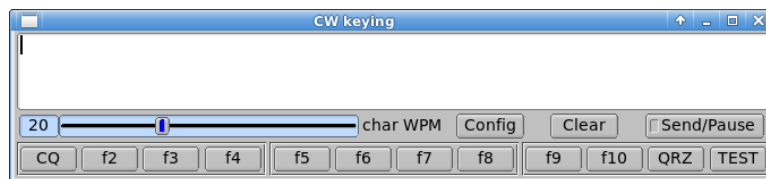

with the main dialog menu item "Keyer/CW keyer".

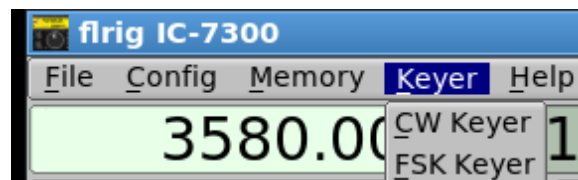

- WPM slider selects the keyer speed.
- Clear - clears the text in the transmit buffer.
- Transmit text will marquee to the left as each character is transmitted.
- Send/Pause button toggles sending text.
- Macro buttons / function keys load transmit buffer with canned message.
  - Left click to load macro contents into transmit buffer.
  - Control left click to open macro editor dialog.
- The transmit text buffer must have keyboard focus for character entry. left click on the entry area to gain keyboard focus.

Tip for the function / macro buttons:

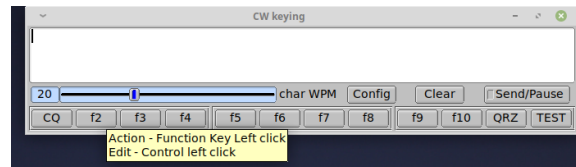

Control-left-click opens:

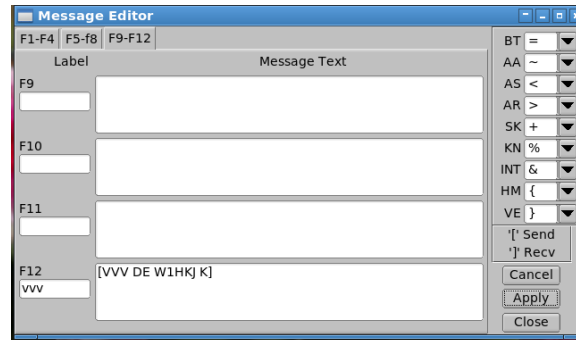

A CQ macro with start/stop (ptt enable/disable):

```
[CQ CQ DE W1HKJ K]
```

Prosign characters can be configured by the user. The macros and prosign assignments are save in the transceiver prefs file.

Config opens:

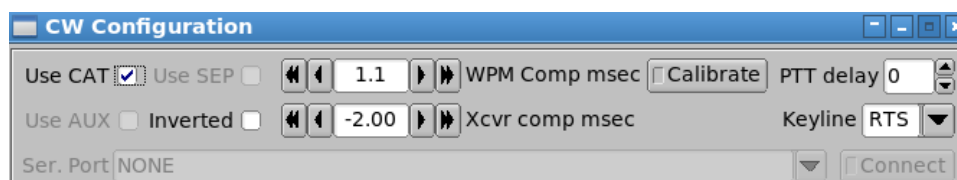

The DTR/RTS port can be either

- shared with the CAT port
- shared with the SEP port
- shared with the AUX port
- a unique serial port configured on this dialog

Select either DTR or RTS for the keyline as required by h/w.

Calibrate button sends standard "PARIS " word, WPM times. Program measures actual time to transmit and sets compensation value. WPM Comp msec can be adjusted by user.

Xcvr comp msec is used to increase or decrease each key down interval by the specified time interval.

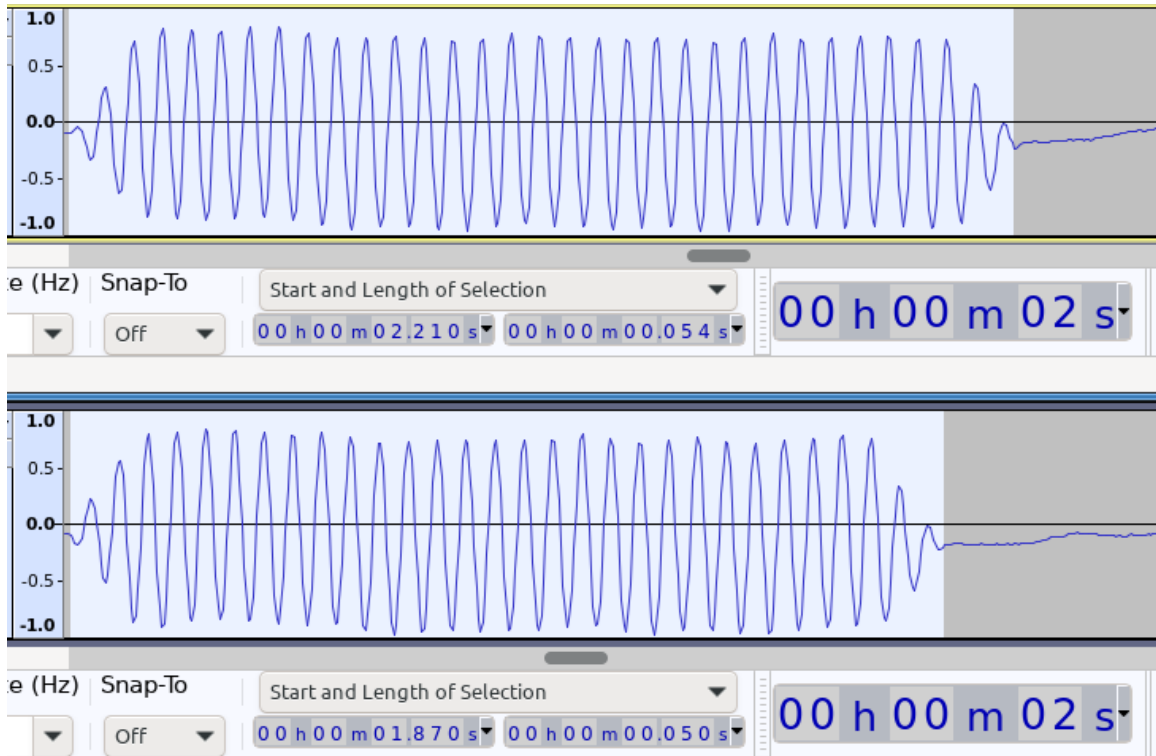

Figure 10.1 7300 CW DTR/RTS keying @ 24 WPM

The effect of a -2 msec Xcvr comp adjustment is clearly seen and easily heard.

It is especially important to correct weight errors introduced by the transceiver keying circuits when operating QRQ (high speed CW). At 80 wpm 2 msec is a significant part of the target dit interval of 15 msec.

PTT delay is in milliseconds. Enter a non-zero value to enable a delay between the PTT-on and the first CW keyline closure. The same delay will be applied to the last CW keyline closure and PTT-off.

The CW keyer is specifically designed to work with a DTR/RTS keyline to emulate the closure of a CW key. Several transceivers have this capability built in to the hardware. Some expose a separate keying port (FT-991A) and some share the CAT serial port (IC-7300). A simple DTR/RTS keying circuit can also provide the h/w interface. This one provides galvanic isolation:

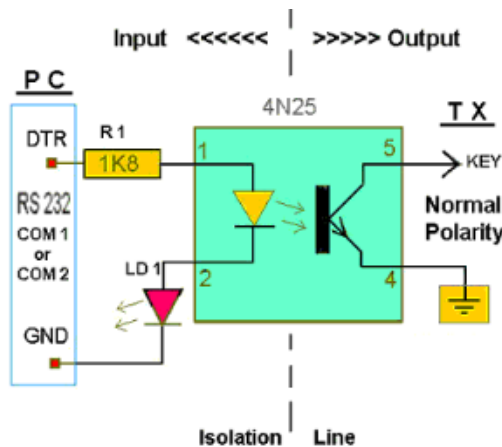

Inexpensive USB serial-to-CW-keyline devices are available from internet vendors. This is one sold by Amazon.com and WalMart.com.



Eujgoov 3.5mm USB Cable, Automatic Shooting Module for CwType, for Hamradio, and for N1mm LD-C103

Visit the Eujgoov Store  
4.0 ★★★★★ 1 rating

\$13<sup>42</sup>

Returnable until Jan 31, 2024

Brand	Eujgoov
Connector Type	Auxiliary, USB
Cable Type	USB
Color	Default
Connector Gender	Male-to-Male

About this item

- APPLICABLE EQUIPMENTS: This product support for CwType, for Hamradio, and for N1mm LD-C103-3.5mm
- LONG SERVICE LIFE: Plug after one time injection molding, strong and not easy to break the needle, beautiful and durable
- GOOD DURABILITY: Made of excellent ABS material, resistant and oxidation resistant to increase service life

[Return to Contents](#)



# Chapter 11

## FSK Keyer

Open the FSK keyer dialog

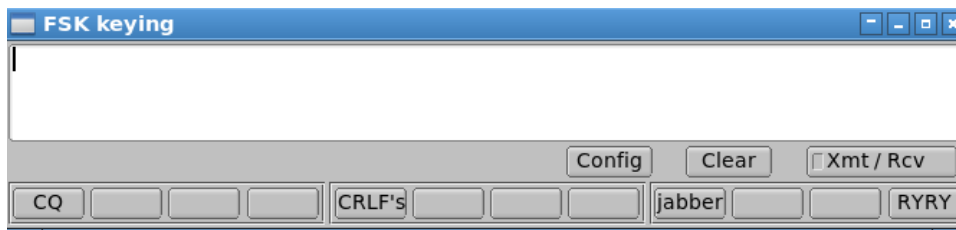

with the main dialog menu item "Keyer/FSK keyer".

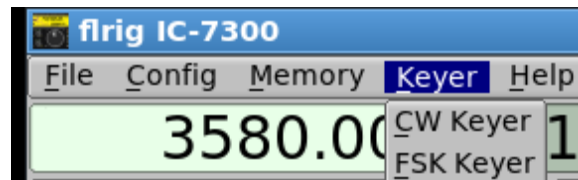

Config opens:

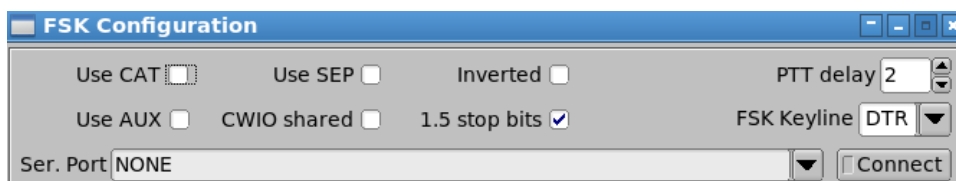

The DTR/RTS port can be either

- shared with the CAT port
- shared with the AUX port
- shared with the SEP port
- shared port with CWIO (if separate)

- a unique serial port configured on this dialog
- Inverted - enable if interface requires a Mark/Space reversed signal level
- select either DTR or RTS for the keyline as required by h/w, selection must not conflict with CW keyline

PTT delay is in milliseconds. Enter a non-zero value to enable a delay between the PTT-on and the first FSK keyline closure. The same delay will be applied to the last FSK keyline closure and PTT-off.

Control-left-click opens:

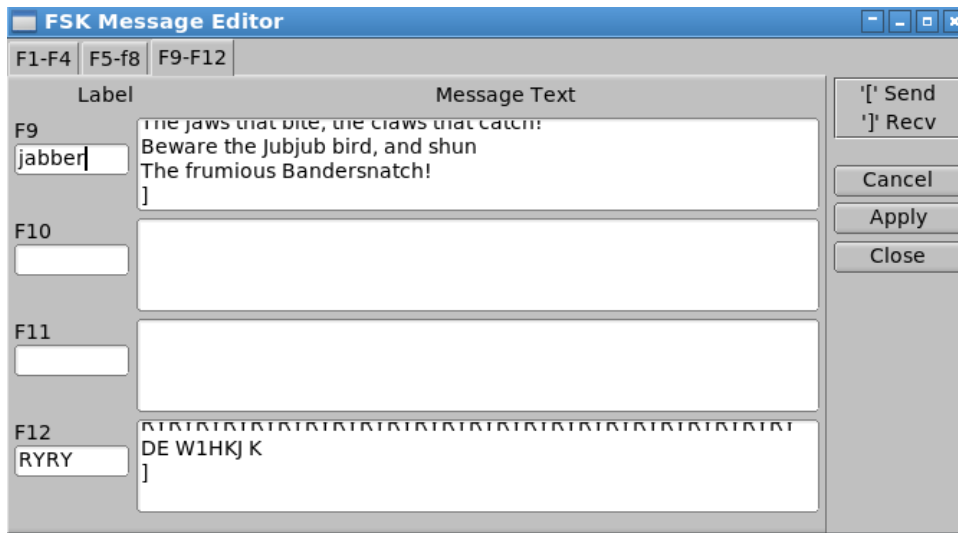

An RY macro with start/stop (ptt enable/disable):

```
[RURYRURYRURYRURYRURYRURYRURYRURYRURYRURYRURYRURYRURY DE W1HKJ K]
```

[Return to Contents](#)

# Chapter 12

## User-Defined Commands

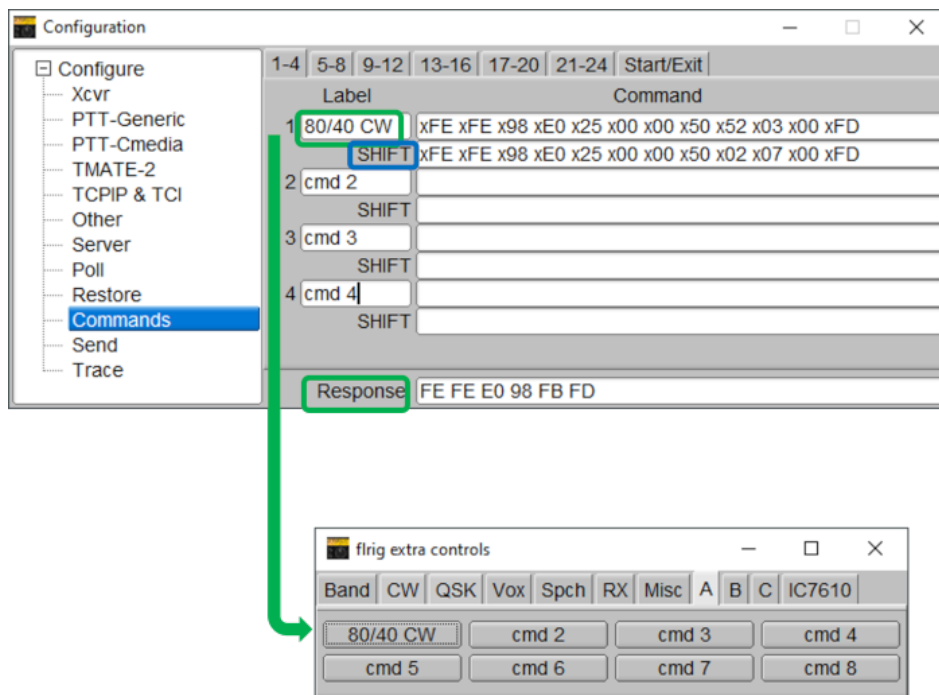

Figure 12.1 Defining Commands for Extra Controls A, B, C Tabs

Frig supports 24 unshifted and 24 shifted user-defined commands. The commands are defined via the Configuration dialog "Commands" tab and are invoked via buttons on the A, B, and C tabs on the frig extra controls dialog. Refer to your rig's remote interface control documentation to learn how to construct a command.

As shown in the Figure, the user provides text for the button label and an appropriate command string for their radio. The command can be tested by clicking on the button in the extra controls dialog and examining the response in the Configuration dialog. In the example, the unshifted command sets the frequency in use on the Main band of an Icom IC-7610 radio to the 80 meter CW range, and the shifted command sets it to the 40 meter CW range (these commands only affect frequency - not mode). In the label in this example, the '/' is used as a way to distinguish the unshifted/shifted functions.

The command string must comply with the transceiver requirements. If ASCII text is used, as with transceivers based on the Kenwood command set, you enter the string without spaces; e.g.,

FA;

to read the A vfo .

For binary strings, used in older Yaesu transceivers and all Icom CI-V type transceivers, you need to enter the string as space-delineated hex values; e.g.,

Yaesu: x00 x00 x00 x01 x05

Icom: xFE xFE x70 xE0 x1A x05 x00 x92 x00 xFD

Additionally, the user can define commands that should be executed during program start-up or termination by making entries on the Start/Exit tab of the Commands configuration page.

### 12.0.1 Send Command String

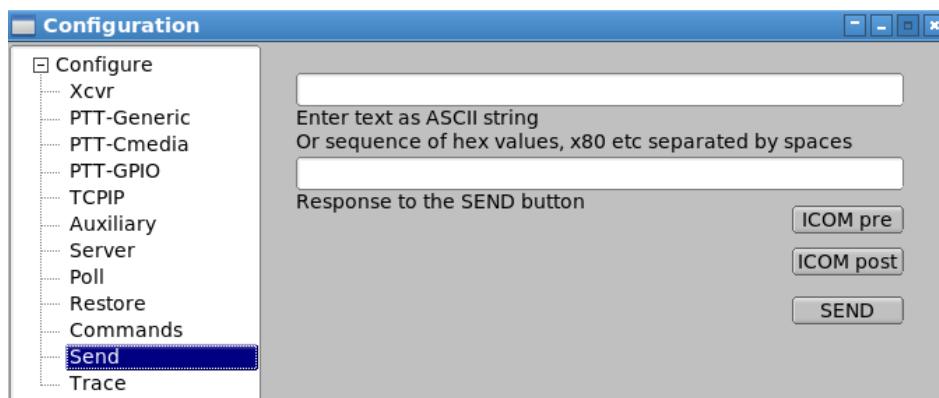

Figure 12.2 I/O Ports - Sending

Testing your transceiver commands. FLRIG might not support a particular CAT command for your transceiver. You can test the support for a particular command using the "Send Cmd" tab. The command string must comply with the transceiver requirements. If ASCII text is used, as with transceivers based on the Kenwood command set you enter the string without spaces, i.e.

FA;

to read the A vfo .

For binary strings, used in older Yaesu transceivers, and all Icom CI-V type transceivers you need to enter the string as space delineated hex values, i.e.

Yaesu: x00 x00 x00 x01 x05

Icom: xFE xFE x70 xE0 x1A x05 x00 x92 x00 xFD

The button "ICOM pre" and "ICOM post" will insert the preamble and postamble hex code sequences for the selected Icom transceiver.

Press the SEND button to transfer the command to the transceiver. The response will appear in the lower text control.

The diamond indicators will be lit for transceiver and fldigi connections respectively.

[Return to Contents](#)

## Chapter 13

# Controlling Multiple Transceivers

You can have multiple instances of flrig running, each controlling a separate and unique transceiver. Doing this requires a separate configuration folder for each target transceiver. Either start flrig from a command line or copy the desktop launch icon and then modify it's "target" executable. In either case you will be adding a command line parameter

```
"--config-dir <target-dir>"
```

Note the double dash. The <target-dir> will be unique to each supported transceiver, for example: "C:\↵Users\<user-name>\flrig.ic7200" on Win-10, "/home/<user>/flrig.ic7200" on Linux or OS X. You will have to configure each instance with the correct interface parameters.



[Return to Contents](#)



## Chapter 14

# Configure XmlRpc Server

Flrig accepts remote control via an XmlRpc socket interface. fldigi uses this access method for reading and writing transceiver parameters via flrig. WSJT-X and several other third party programs also use this method.

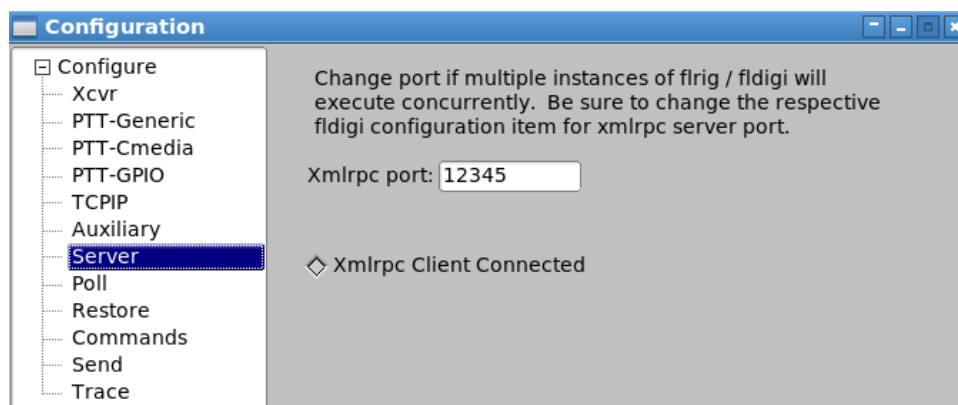

Figure 14.1 Configure server

## 14.1 flrig XmlRpc Command Structures

<code>main.set_frequency</code>	<code>d:d</code>	set current VFO in Hz
<code>main.get_version</code>	<code>s:n</code>	returns version <code>std::string</code>
<code>rig.get_AB</code>	<code>s:n</code>	returns vfo in use A or B
<code>rig.get_bw</code>	<code>A:n</code>	return BW of current VFO
<code>rig.get_bws</code>	<code>A:n</code>	return table of BW values
<code>rig.get_bwA</code>	<code>A:n</code>	return BW of vfo A
<code>rig.get_bwB</code>	<code>A:n</code>	return BW of vfo B
<code>rig.get_pbt</code>	<code>A:n</code>	return passband tuning
<code>rig.get_pbt_inner</code>	<code>i:i</code>	return passband inner
<code>rig.get_pbt_outer</code>	<code>i:i</code>	return passband outer
<code>rig.get_info</code>	<code>s:n</code>	return an info <code>std::string</code>
<code>rig.get_mode</code>	<code>s:n</code>	return MODE of current VFO
<code>rig.get_modeA</code>	<code>s:n</code>	return MODE of current VFO A
<code>rig.get_modeB</code>	<code>s:n</code>	return MODE of current VFO B
<code>rig.get_modes</code>	<code>A:n</code>	return table of MODE values

```

rig.get_sideband      s:n  return sideband (U/L)
rig.get_notch        i:n  return notch value
rig.get_ptt          i:n  return PTT state
rig.get_power        i:n  return power level control value
rig.get_pwrmeter     s:n  return PWR out
rig.get_pwrmeter_scale s:n  return scale for power meter
rig.get_pwrmax       s:n  return maximum power available
rig.get_swrmeter     s:n  return SWR meter reading
rig.get_SWR          s:n  return SWR value
rig.get_smeter       s:n  return Smeter
rig.get_DBM          s:n  return Smeter in dBm
rig.get_Sunits       s:n  return Smeter in S units
rig.get_split        i:n  return split state
rig.get_update       s:n  return update to info
rig.get_vfo          s:n  return current VFO in Hz
rig.get_vfoA         s:n  return vfo A in Hz
rig.get_vfoB         s:n  return vfo B in Hz
rig.get_xcvr         s:n  returns name of transceiver
rig.get_volume       i:n  returns volume control value
rig.get_rfgain       i:n  returns rf gain control value
rig.get_micgain      i:n  returns mic gain control value
rig.set_AB           n:s  set VFO A/B
rig.set_bw           i:i  set BW iaw BW table
rig.set_bandwidth    i:i  set bandwidth to nearest requested value
rig.set_BW          i:i  set L/U pair
rig.set_pbt         i:A  set pbt inner/outer
rig.set_pbt_inner    i:i  set pbt inner
rig.set_pbt_outer    i:i  set pbt outer
rig.set_frequency    d:d  set current VFO in Hz
rig.set_mode         i:s  set MODE iaw MODE table
rig.set_modeA        i:s  set MODE A iaw MODE table
rig.set_modeB        i:s  set MODE B iaw MODE table
rig.set_notch        n:i  set NOTCH value in Hz
rig.set_power        n:i  set power control level, watts
rig.set_ptt          n:i  set PTT 1/0 (on/off)
rig.set_vfo          d:d  set current VFO in Hz
rig.set_vfoA         d:d  set vfo A in Hz
rig.set_vfoB         d:d  set vfo B in Hz
rig.set_split        n:i  set split 1/0 (on/off)
rig.set_volume       n:i  set volume control
rig.set_rfgain       n:i  set rf gain control
rig.set_micgain      n:i  set mic gain control
rig.set_ptt_fast     n:i  deprecated; use set_ptt
rig.set_vfoA_fast    d:d  deprecated; use set_vfoA
rig.set_vfoB_fast    d:d  deprecated; use set_vfoB
rig.set_verify_AB    n:s  set & verify VFO A/B
rig.set_verify_bw    i:i  set & verify BW iaw BW table
rig.set_verify_bandwidth i:i  set & verify bandwidth to nearest requested value
rig.set_verify_BW    i:i  set & verify L/U pair
rig.set_verify_frequency d:d  set & verify current VFO in Hz
rig.set_verify_mode  i:s  set & verify MODE iaw MODE table
rig.set_verify_modeA i:s  set & verify MODE A iaw MODE table
rig.set_verify_modeB i:s  set & verify MODE B iaw MODE table
rig.set_verify_notch n:i  set & verify NOTCH value in Hz
rig.set_verify_power n:i  set & verify power control level, watts
rig.set_verify_ptt   n:i  set & verify PTT 1/0 (on/off)
rig.set_verify_vfoA d:d  set & verify vfo A in Hz
rig.set_verify_vfoB d:d  set & verify vfo B in Hz
rig.set_verify_split n:i  set & verify split 1/0 (on/off)
rig.set_verify_volume n:i  set & verify volume control
rig.set_verify_rfgain n:i  set & verify rf gain control
rig.set_verify_micgain n:i  set & verify mic gain control
rig.swap            n:n  execute vfo swap

```



```

rig.tune                n:n  enable transceiver tune function
rig.cat_string          s:s  execute CAT std::string
rig.cat_priority       s:s  priority CAT std::string
rig.shutdown           i:n  shutdown xcvr & flrig
rig.cwio_set_wpm       n:i  set cwio WPM
rig.cwio_text          i:s  send text via cwio interface
rig.cwio_send          n:i  cwio transmit 1/0 (on/off)
rig.fskio_text         i:s  send text via fsdio interface
rig.mod_vfoA           d:d  modify vfo A +/- NNN Hz
rig.mod_vfoB           d:d  modify vfo B +/- NNN Hz
rig.mod_vol            n:i  modify volume control +/- NNN %
rig.mod_pwr            n:i  modify power control level +/- NNN watts
rig.mod_rfg            n:i  modify rf gain by +/- NNN units
rig.mod_cwio_wpm       n:i  modify cwio WPM by +/- NNN wpm
rig.mod_bw             i:i  modify bandwidth +- to nearest new value
rig.vfoA2B            n:n  set vfo B to vfo A freq/mode
rig.freqA2B            n:n  set freq B to freq A
rig.modeA2B            n:n  set mode B to mode A
rig.cmd                n:i  execute command button 1..24; 25..48(shift)

```

The xmlrpc command structure can be accessed using the menu item help/xml-help.

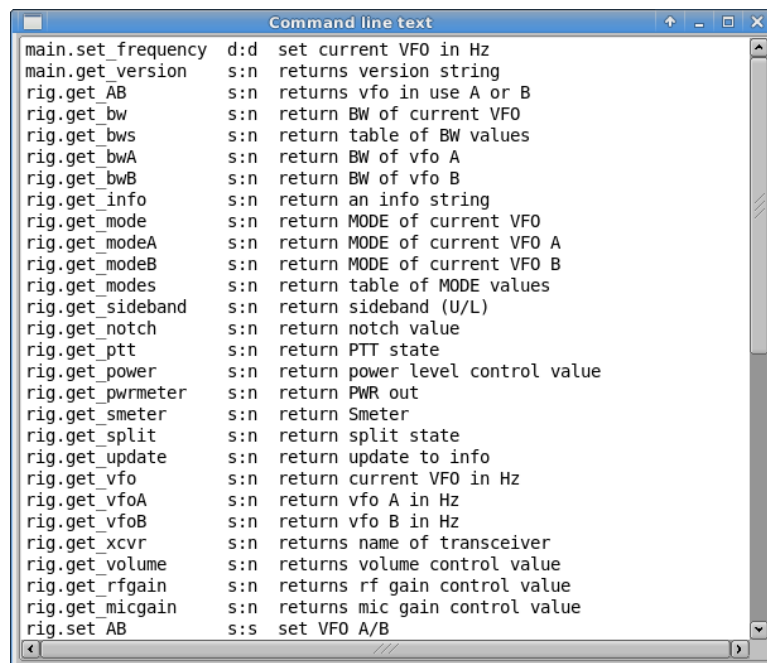

```

main.set frequency    d:d  set current VFO in Hz
main.get version      s:n  returns version string
rig.get_AB            s:n  returns vfo in use A or B
rig.get_bw            s:n  return BW of current VFO
rig.get_bws           s:n  return table of BW values
rig.get_bwA           s:n  return BW of vfo A
rig.get_bwB           s:n  return BW of vfo B
rig.get_info          s:n  return an info string
rig.get_mode          s:n  return MODE of current VFO
rig.get_modeA         s:n  return MODE of current VFO A
rig.get_modeB         s:n  return MODE of current VFO B
rig.get_modes         s:n  return table of MODE values
rig.get_sideband      s:n  return sideband (U/L)
rig.get_notch         s:n  return notch value
rig.get_ptt           s:n  return PTT state
rig.get_power         s:n  return power level control value
rig.get_pwrmeter      s:n  return PWR out
rig.get_smeter        s:n  return Smeter
rig.get_split         s:n  return split state
rig.get_update        s:n  return update to info
rig.get_vfo           s:n  return current VFO in Hz
rig.get_vfoA          s:n  return vfo A in Hz
rig.get_vfoB          s:n  return vfo B in Hz
rig.get_xcvr          s:n  returns name of transceiver
rig.get_volume        s:n  returns volume control value
rig.get_rfgain        s:n  returns rf gain control value
rig.get_micgain       s:n  returns mic gain control value
rig.set AB            s:s  set VFO A/B

```

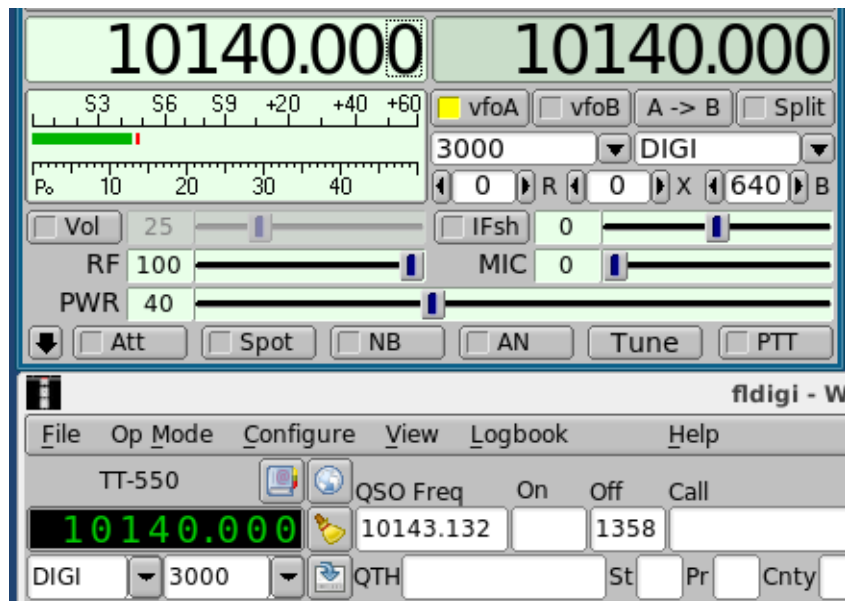
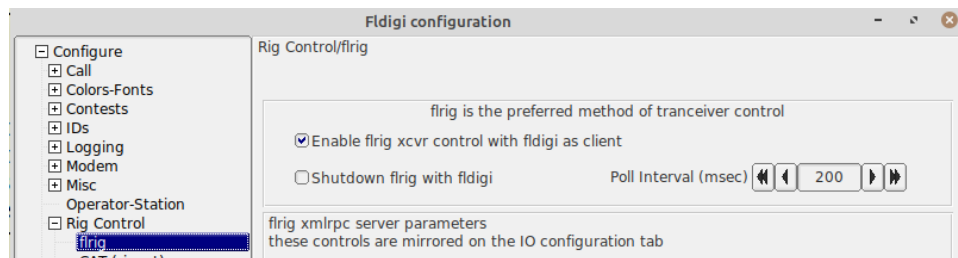

Figure 14.2 FLRIG/FLDIGI

Operating FLRIG with FLDIGI requires a simple setup in FLDIGI. Open the fldigi configuration dialog to *rig control / flrig*



Deselect all other rig control methods and enable fldigi as an flrig client. Xmlrpc is used via a local socket device for the two programs to communicate. flrig acts as the server and fldigi the client. There is no requirement for start / stop ordering of the programs.

FLRIG sends rig configuration data to FLDIGI when the two programs initially recognize each other. This data is used to populate the rig name, the available modes and the available bandwidths.

After this initial communications the operator can set the paired controls from either FLDIGI or FLRIG. The two programs will remain synchronized. The data from the computer to the transceiver is always from FLRIG.

Fllrig can service multiple xmlrpc clients. Changes either at the transceiver, flrig, or one of the clients will quickly be reflected at the other entities.

[Return to Contents](#)

# Chapter 15

## Remote frig

### 15.1 Remote Frig Server

frig's xmlrpc server interface is always executing. If the computer that is connected to the transceiver is on a local area network then another computer may access that instance of frig via the xmlrpc interface. This is an instance of my FT-710 being controlled on a computer whose network address name is "tk7"

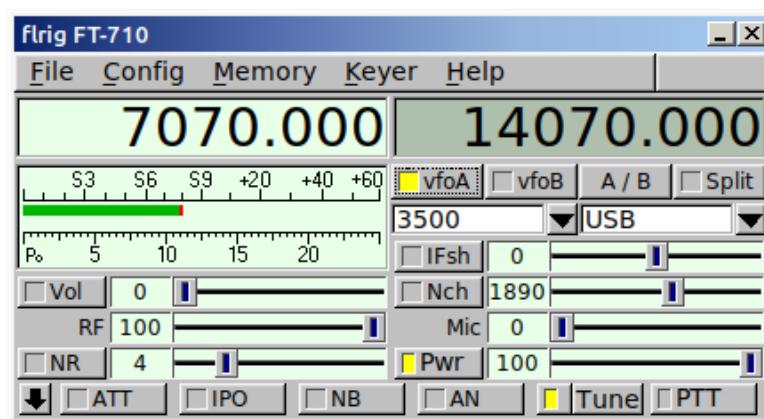

Figure 15.1 frig server

It has been configured to use the default xmlrpc port

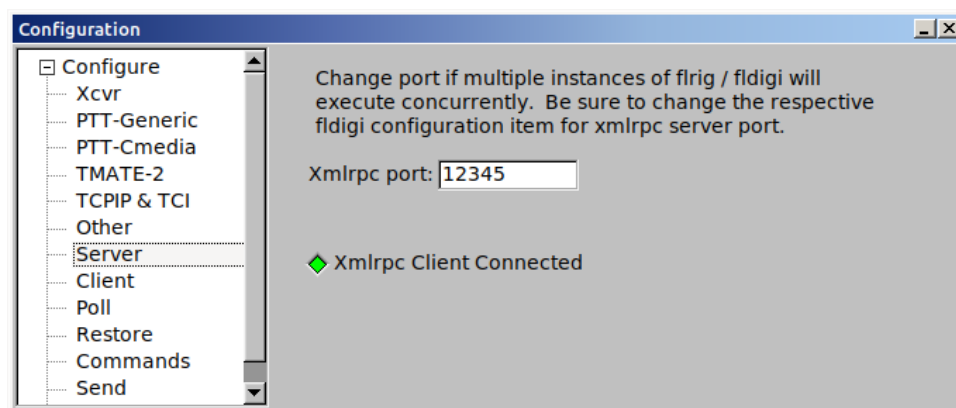

Figure 15.2 frig server

## 15.2 Remote Client

A second computer on the local area network has been configured to run an instance of flrig that connects to the above server.

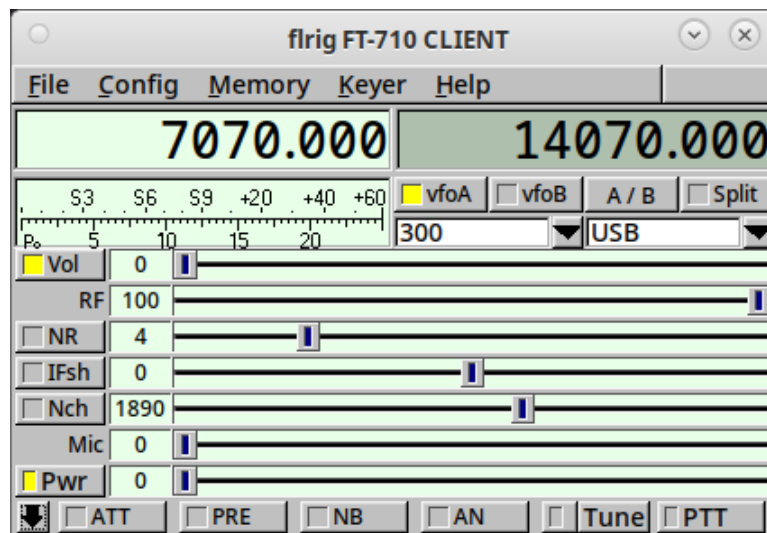

Figure 15.3 flrig client

Note that the title bar indicates that this is a client and not directly connected to the transceiver.

The server address and port must be configured on the client tab before attempting to connect to the external xmlrpc server.

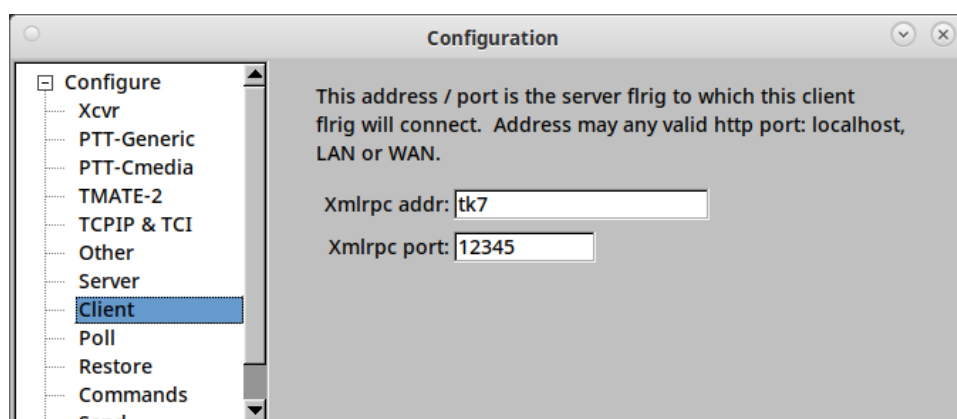

Figure 15.4 flrig server port

The Xcvr tab is then configured to use the xmlrpc interface by selecting "xml\_client" in lieu of a serial port interface, and pressing the Init button.

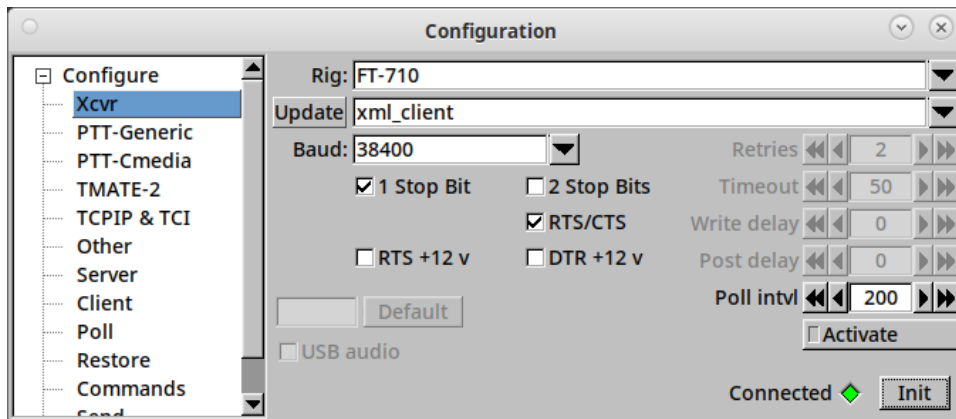

Figure 15.5 select xml\_client

[Return to Contents](#)



## Chapter 16

# Program Debugging

### 16.1 Event Log

Several debugging tools are available in flrig, including the ability to observe code execution in various parts of the program.

The event log is opened from the "Help/Events" menu item. It allows you to view the serial and xmlrpc data exchanges between FLRIG, FLDIGI, xmlrpc transactions, and the transceiver.

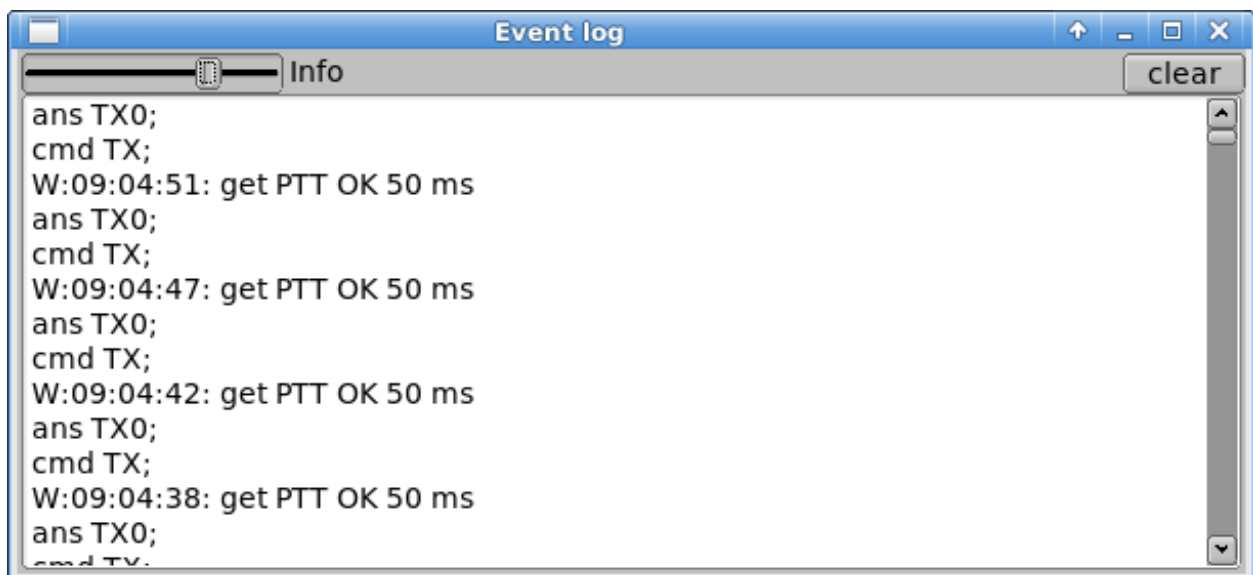

Figure 16.1 Event Log

### 16.2 Tracing Program Execution

The trace tool sends time annotated data to both a viewing dialog and a file named "trace.txt" which is written to the flrig files folder. The trace tool is very useful to the programmer developing a 3rd party application using the flrig xmlrpc server. It may also be used at the request of a support person assisting the user with transceiver connection or data stream issues.

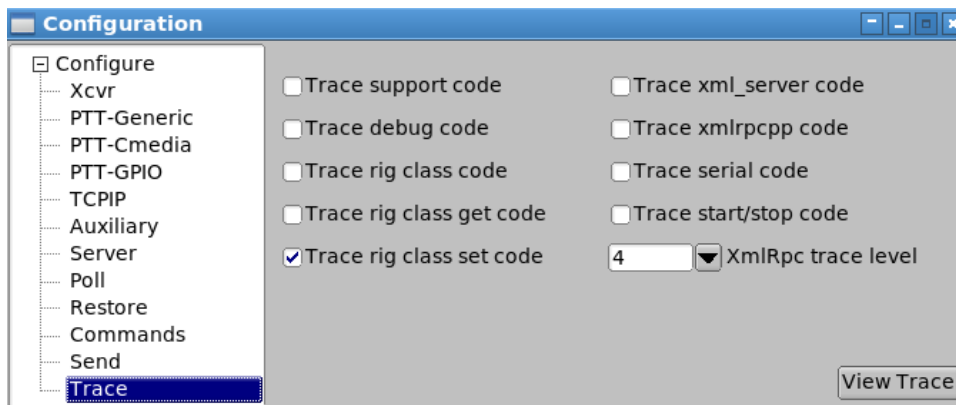

Figure 16.2 Configure code execution trace

- Trace support code - main processing loop execution points.
- Trace debug code - replicate the event log debugging output.
- Trace rig class code - execution points within a specific transceiver class (not for all).
- Trace xml\_server code - execution points within the xmlrpc interface code for i/o to/from fldigi.
- Trace xmlrpcpp code - sent and received xmlrpc data packets  
six levels of detail 0 ... 5 can be specified.

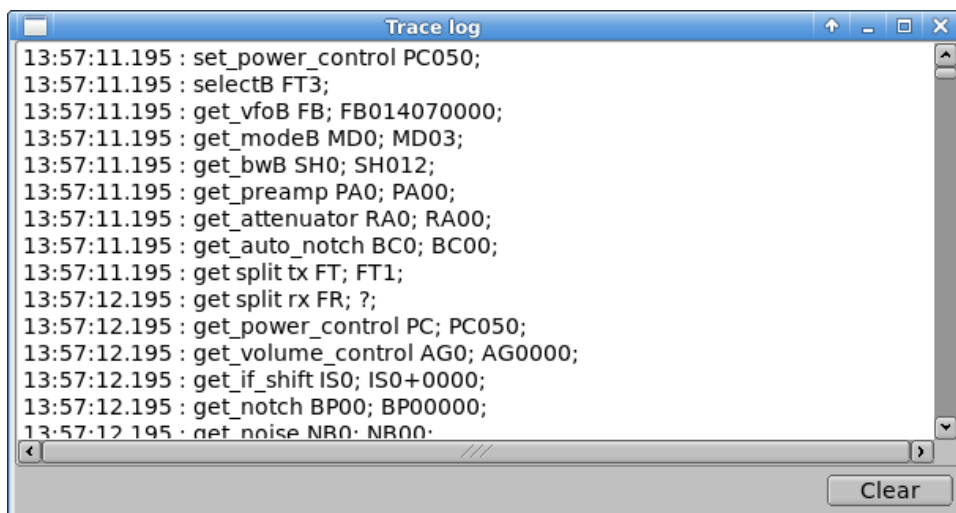

Figure 16.3 Example showing support code trace

[Return to Contents](#)



## Chapter 17

# Supported Transceivers

Each table entry is a clickable link to a specific transceiver.

Elecraft	Icom	Kenwood	Ten-Tec	Yaesu	Other
<a href="#">K2</a>	<a href="#">IC-703</a>	<a href="#">TS 140</a>	<a href="#">TT 516</a>	<a href="#">FT 100D</a>	<a href="#">AOR5000</a>
<a href="#">KX2</a>	<a href="#">IC-705</a>	<a href="#">TS 440</a>	<a href="#">TT DELTA-II</a>	<a href="#">FT 450</a>	<a href="#">PCR 1000</a>
<a href="#">K3</a>	<a href="#">IC 706 MK IIG</a>	<a href="#">TS 450S</a>	<a href="#">TT 538</a>	<a href="#">FT 450D</a>	<a href="#">RAY 152</a>
<a href="#">KX3</a>	<a href="#">IC-718</a>	<a href="#">TS 480HX</a>	<a href="#">TT 550</a>	<a href="#">FT 736R</a>	
<a href="#">K4</a>	<a href="#">IC 728</a>	<a href="#">TS 480SAT</a>	<a href="#">Omni-VI</a>	<a href="#">FT 747</a>	<a href="#">PowerSDR</a>
	<a href="#">IC 735</a>	<a href="#">TS 570</a>	<a href="#">TT Orion-II</a>	<a href="#">FT 757GX2</a>	<a href="#">Flex 1500</a>
	<a href="#">IC 746</a>	<a href="#">TS 590S</a>	<a href="#">Omni-VII</a>	<a href="#">FT 767</a>	<a href="#">SunSDR2 Pro</a>
	<a href="#">IC 746 Pro</a>	<a href="#">TS 590SG</a>	<a href="#">TT Eagle</a>	<a href="#">FT 817</a>	<a href="#">SmartSDR</a>
	<a href="#">IC 751</a>	<a href="#">TS 790</a>		<a href="#">FT 817BB</a>	<a href="#">TCISDR</a>
	<a href="#">IC 756</a>	<a href="#">TS 850</a>		<a href="#">FT 818ND</a>	
	<a href="#">IC 756 Pro</a>	<a href="#">TS 870S</a>		<a href="#">FT 847</a>	<a href="#">Xiegu 5105</a>
	<a href="#">IC 756 Pro II</a>	<a href="#">TS 890S</a>		<a href="#">FT 857D</a>	<a href="#">Xiegu G90</a>
	<a href="#">IC 756 Pro III</a>	<a href="#">TS 940S</a>		<a href="#">FT 890</a>	<a href="#">Xiegu 6100</a>
	<a href="#">IC 910H</a>	<a href="#">TS 950</a>		<a href="#">FT 891</a>	
	<a href="#">IC 7000</a>	<a href="#">TS 990</a>		<a href="#">FT 897D</a>	<a href="#">FDM-DUO</a>
	<a href="#">IC 7100</a>	<a href="#">TS 2000</a>		<a href="#">FT 900</a>	
	<a href="#">IC 7200</a>			<a href="#">FT 920</a>	
	<a href="#">IC 7300</a>			<a href="#">FT 950</a>	<a href="#">TX500</a>
	<a href="#">IC 7410</a>			<a href="#">FT 990</a>	
	<a href="#">IC 7600</a>			<a href="#">FT 990A</a>	<a href="#">QRP Labs QCX+</a>

Elecraft	Icom	Kenwood	Ten-Tec	Yaesu	Other
	<a href="#">IC 7610</a>			<a href="#">FT 991</a>	<a href="#">QRP Labs QDX</a>
	<a href="#">IC 7700</a>			<a href="#">FT 991A</a>	<a href="#">QRP Labs QMX</a>
	<a href="#">IC 7800</a>			<a href="#">FT 1000/D</a>	
	<a href="#">IC 7851</a>			<a href="#">FT 1000MP</a>	<a href="#">TMD710</a>
	<a href="#">IC 9100</a>			<a href="#">FT 1000MP-A</a>	
	<a href="#">IC 9700</a>			<a href="#">FT 2000</a>	
	<a href="#">IC F8101</a>			<a href="#">FT DX10</a>	
	<a href="#">IC R71</a>			<a href="#">FT DX101D</a>	
				<a href="#">FT DX101MP</a>	
				<a href="#">FT DX1200</a>	
				<a href="#">FT DX3000</a>	
				<a href="#">FT DX5000</a>	
				<a href="#">FT DX9000</a>	

## 17.1 Transceiver Setup Examples

- [FT-991A setup](#)
- [IC 7100 menu setup](#)
- [IC 7300 menu setup](#)
- [IC-7600 Setup](#)
- [TT550 - Pegasus](#)

Additional setup examples may be found on the fldigi wiki: <https://sourceforge.net/p/fldigi/wiki/how-to/>

[Return to Contents](#)

# Chapter 18

## Supported Elecraft Transceivers

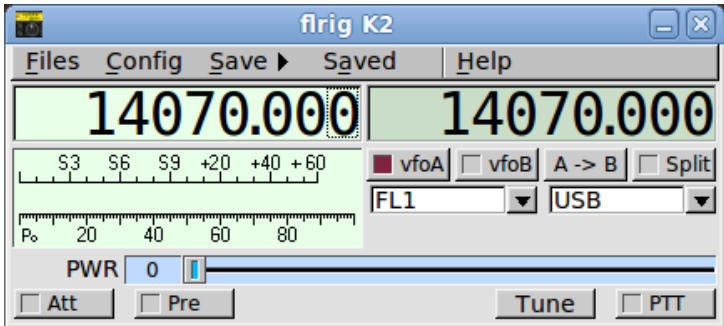

Figure 18.1 K2

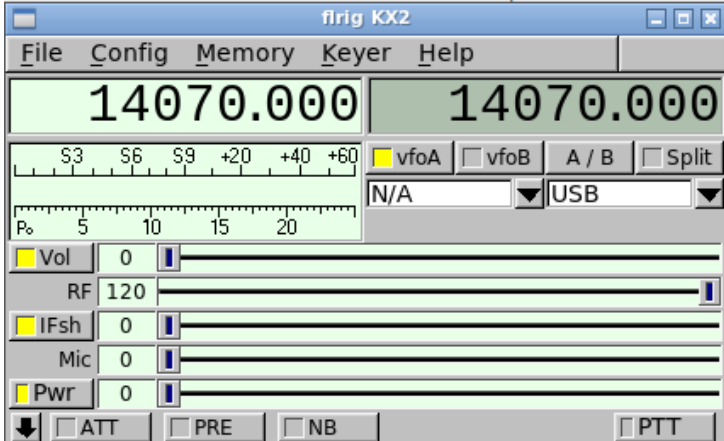

Figure 18.2 KX2

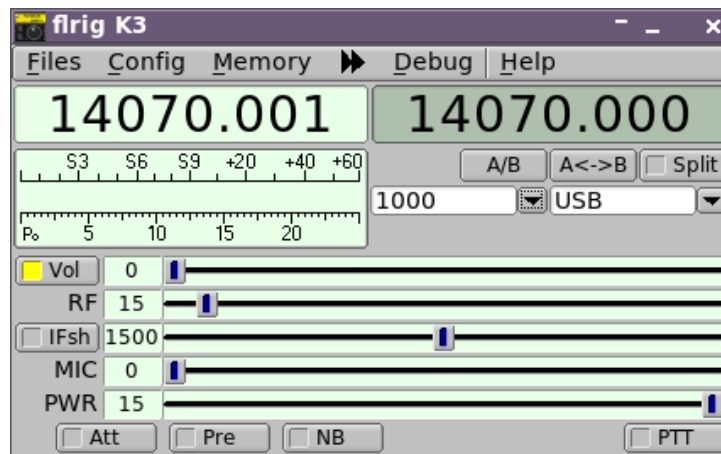

Figure 18.3 K3

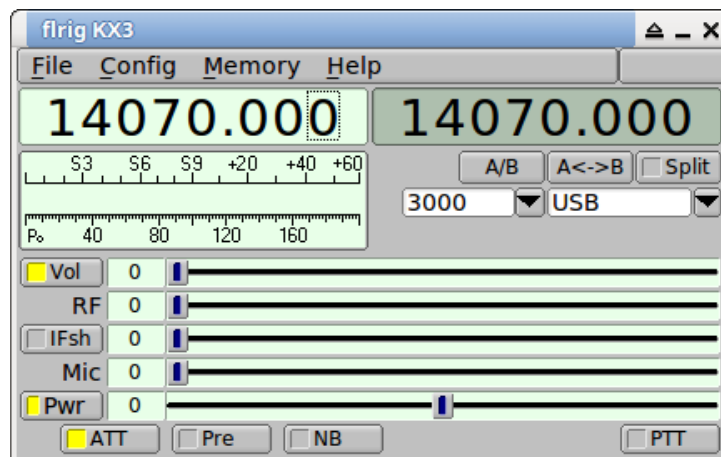

Figure 18.4 KX3

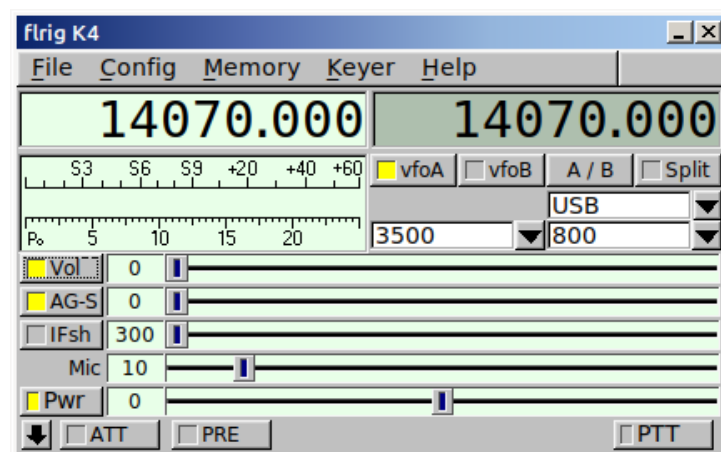

Figure 18.5 K4

[Page Top Return to Contents](#)



# Chapter 19

## Supported ICom Transceivers

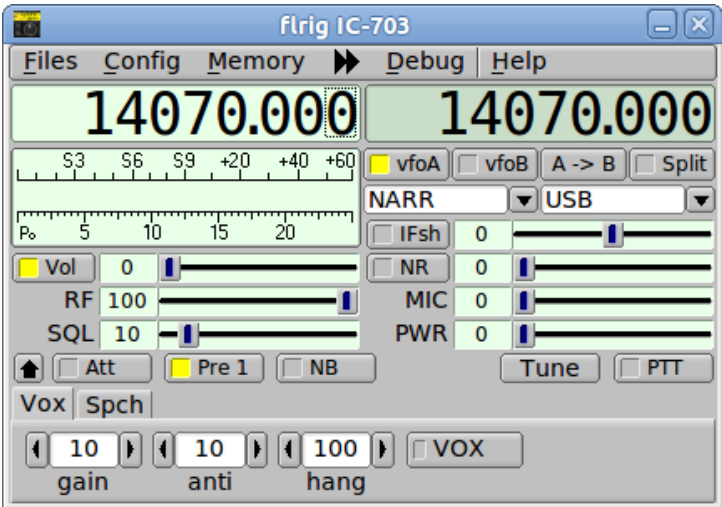

Figure 19.1 IC 703

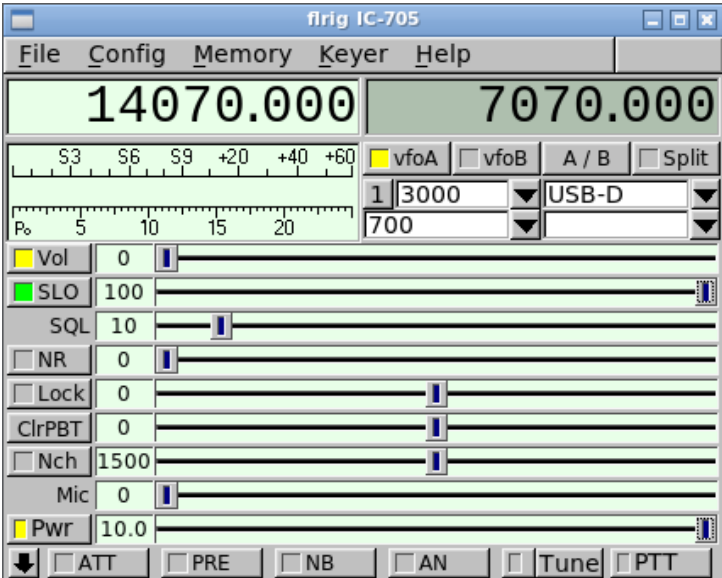

Figure 19.2 IC 705

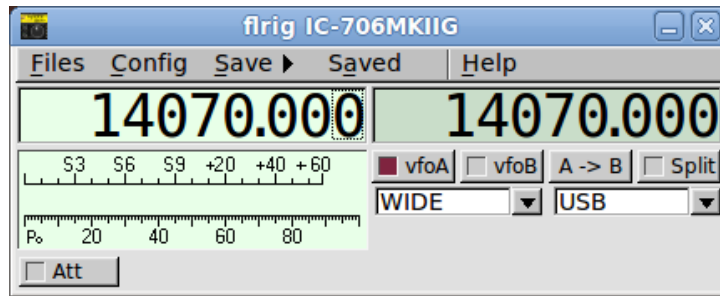

Figure 19.3 IC 706 MKIIG

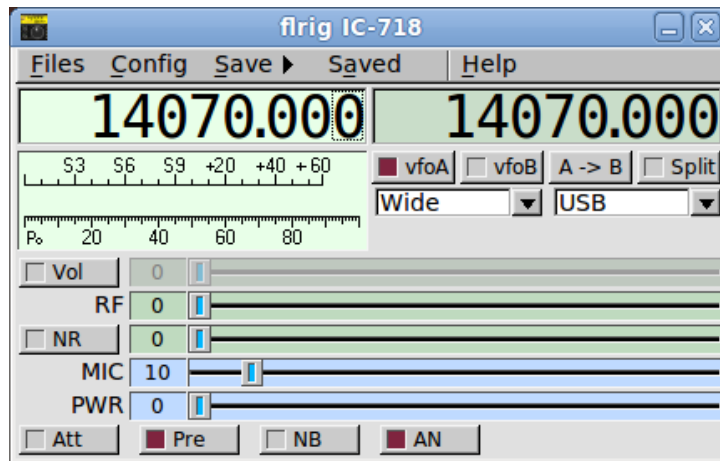

Figure 19.4 IC 718

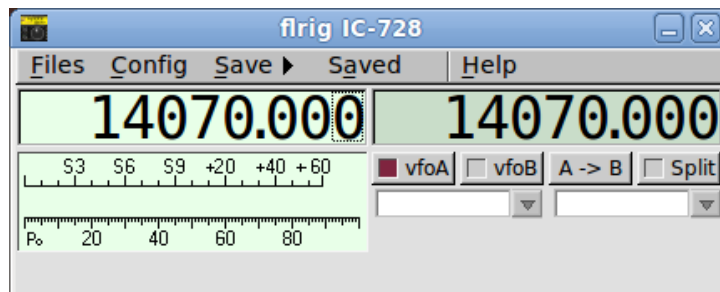

Figure 19.5 IC 728



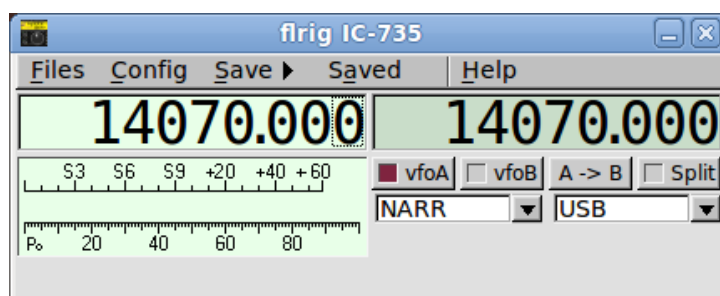

Figure 19.6 IC 735

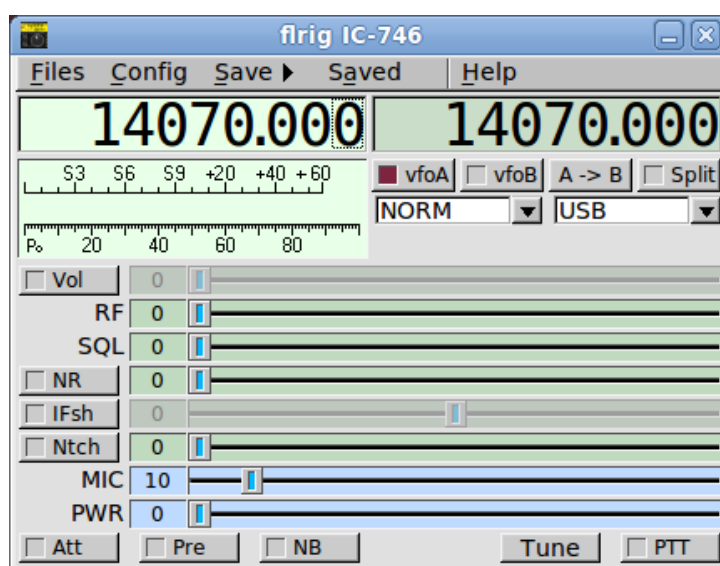

Figure 19.7 IC 746



Figure 19.8 IC 746

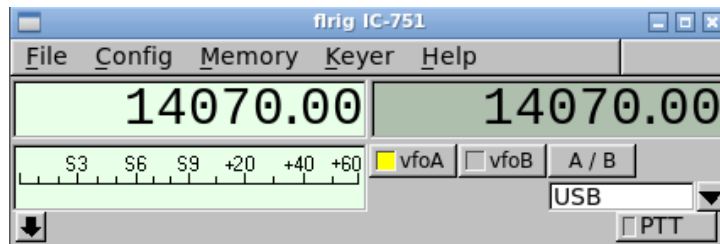

Figure 19.9 IC 751

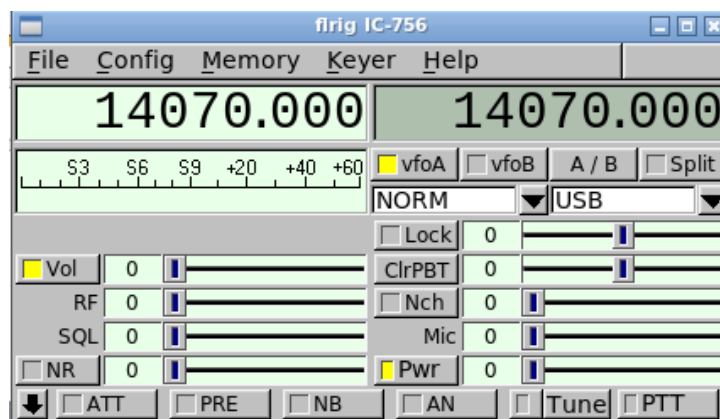

Figure 19.10 IC 756

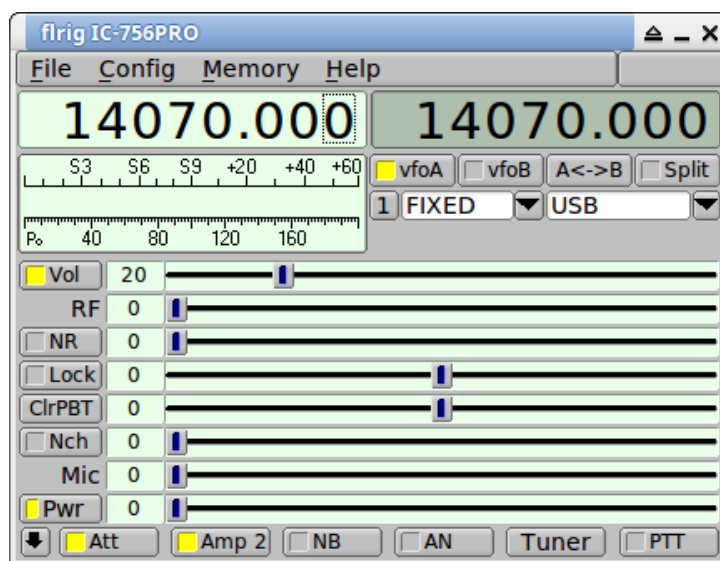

Figure 19.11 IC 756 pro

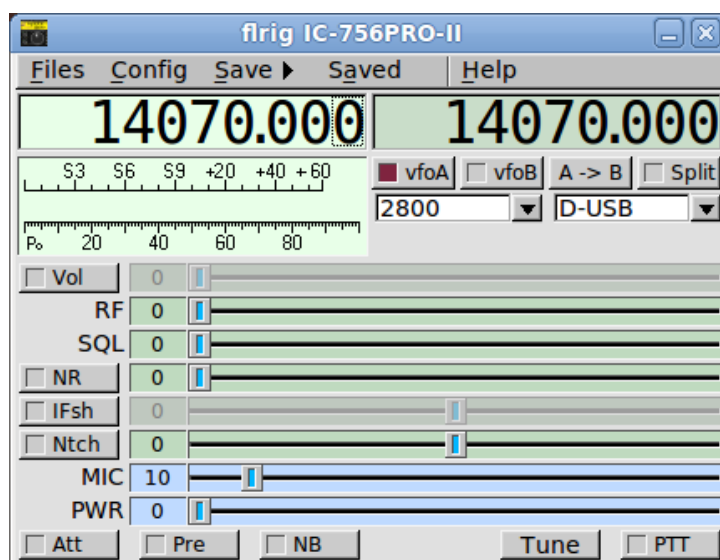

Figure 19.12 IC 756 pro2

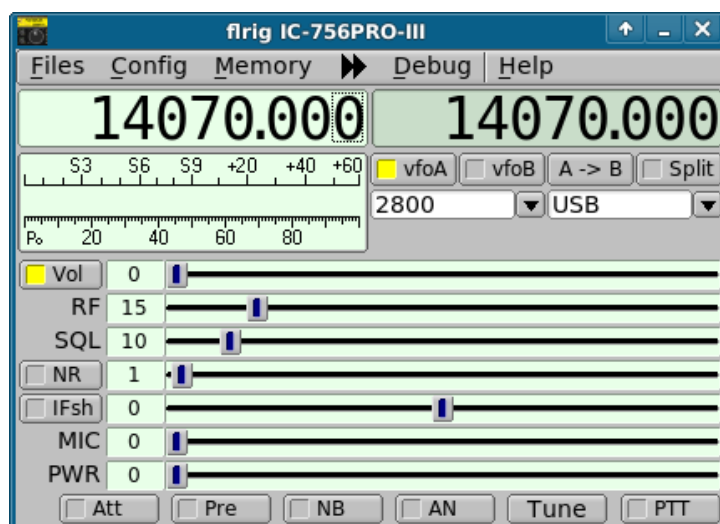

Figure 19.13 IC 756 pro3

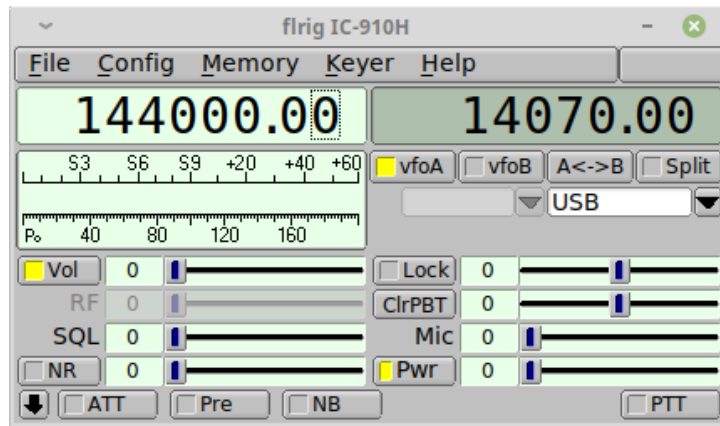

Figure 19.14 IC 910 H

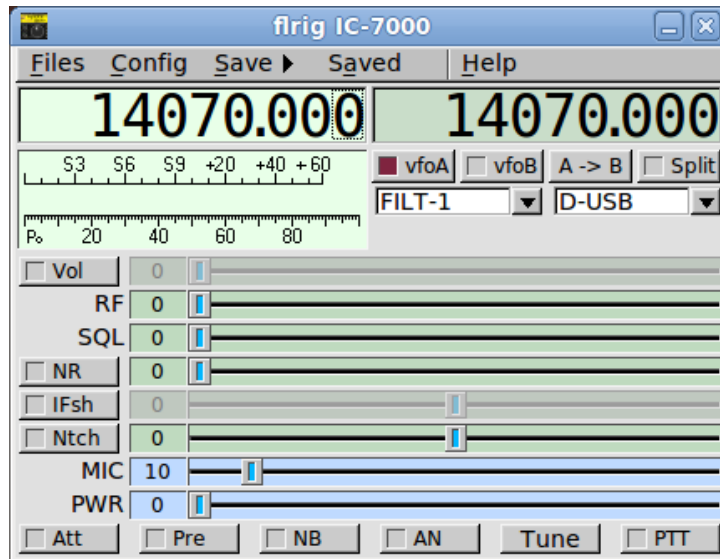

Figure 19.15 IC 7000

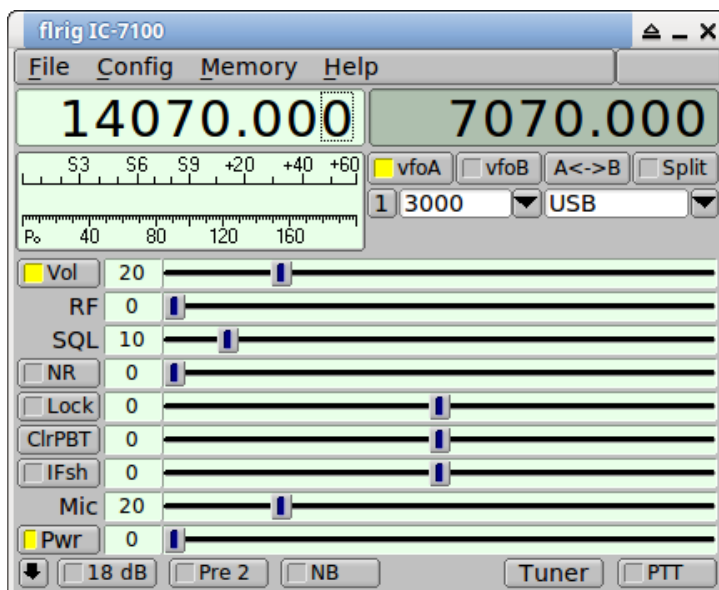

Figure 19.16 /IC 7100

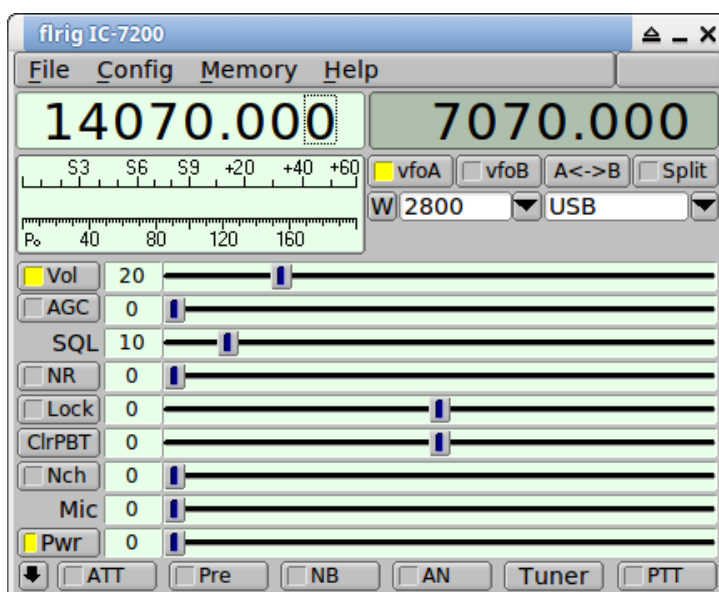

Figure 19.17 IC 7200

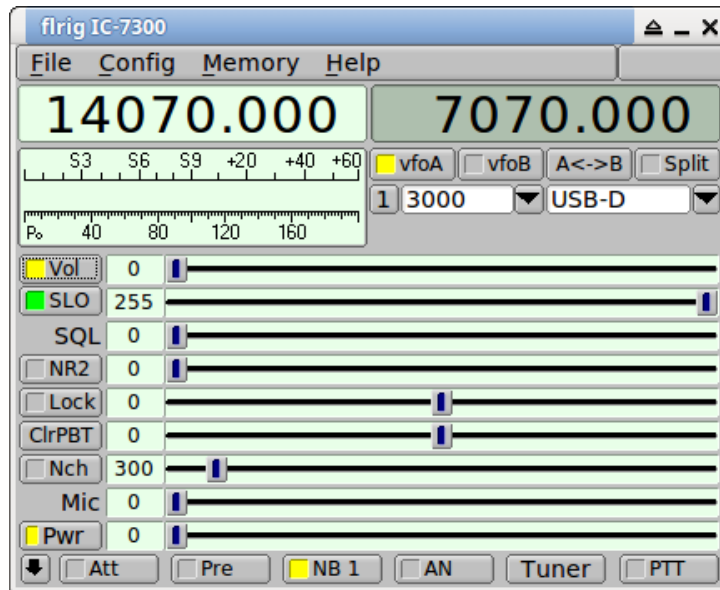

Figure 19.18 IC 7300

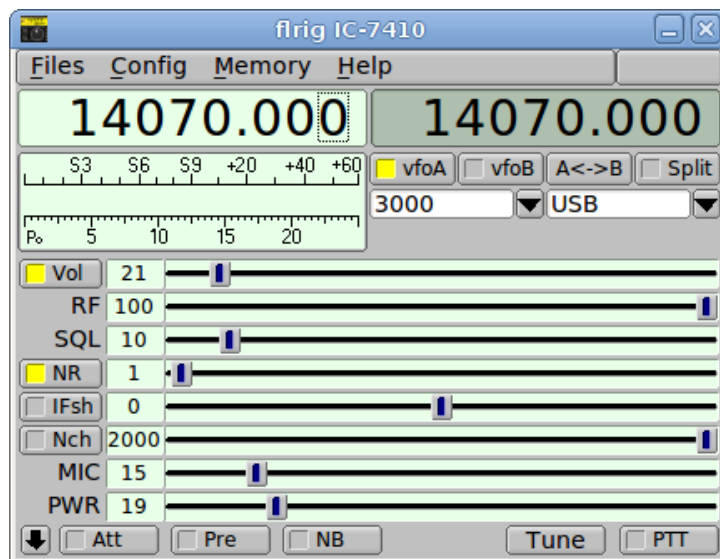

Figure 19.19 IC 7410

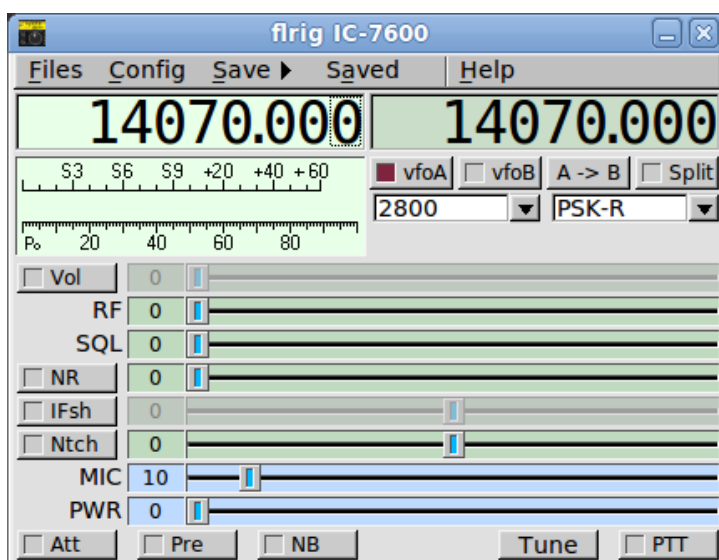

Figure 19.20 IC 7600

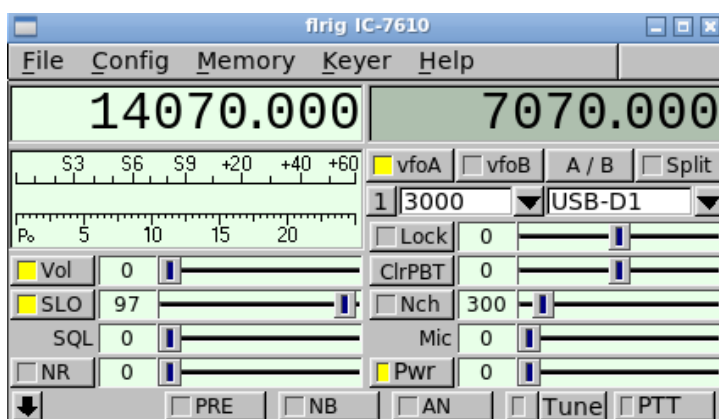

Figure 19.21 IC 7610

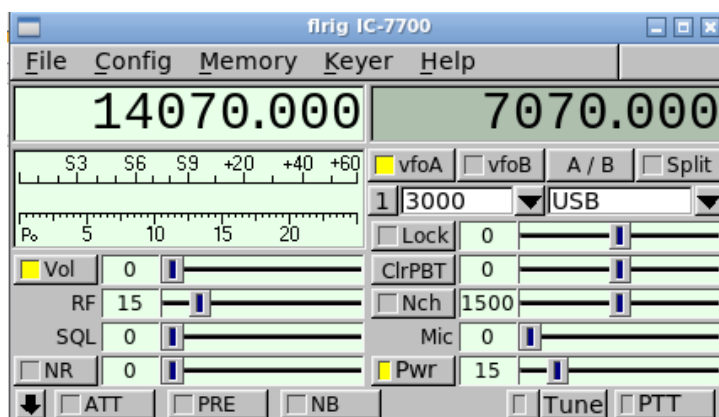

Figure 19.22 IC 7700

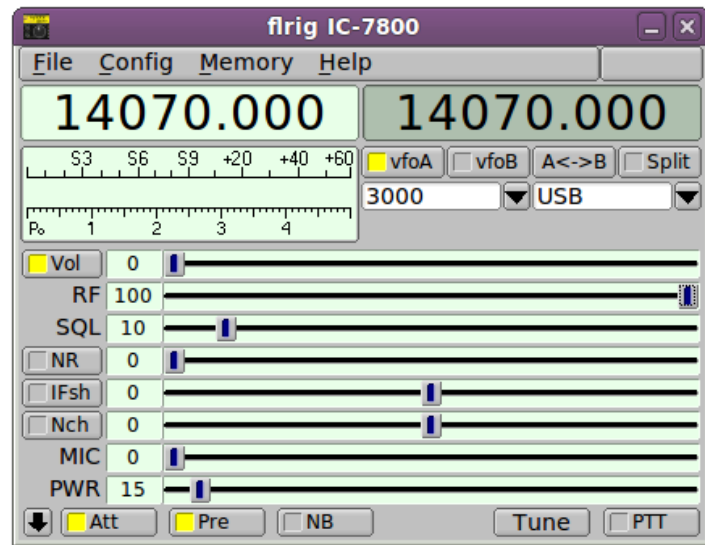

Figure 19.23 IC 7800

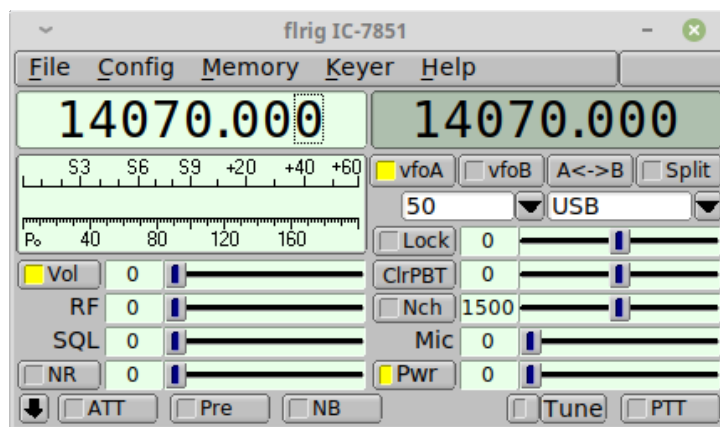

Figure 19.24 IC 7851



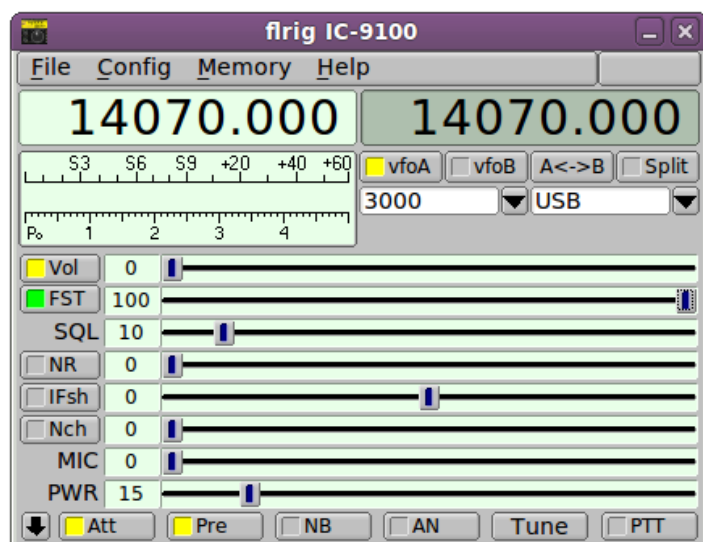

Figure 19.25 IC 9100

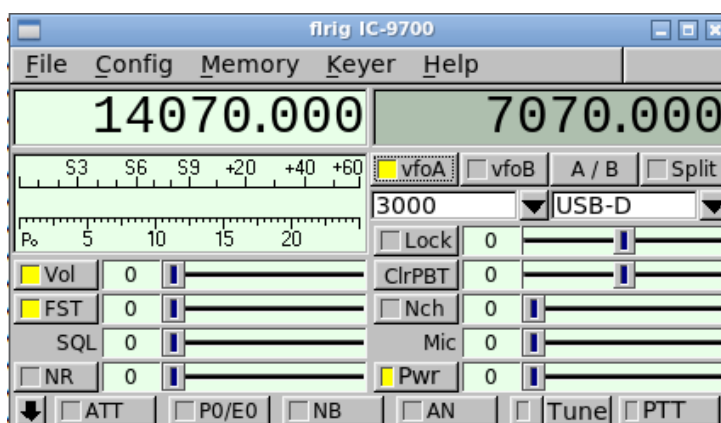

Figure 19.26 IC 9700

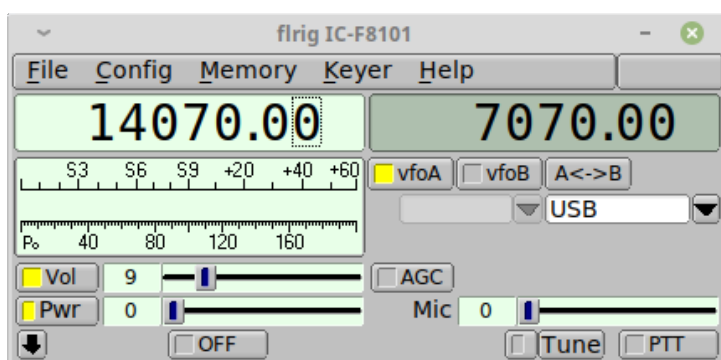

Figure 19.27 IC F8101

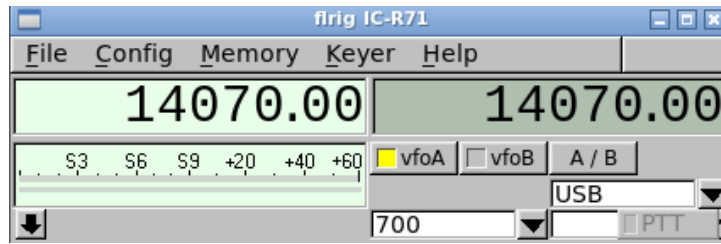

Figure 19.28 IC R71

[Page Top Return to Contents](#)

## Chapter 20

# Supported Kenwood Transceivers

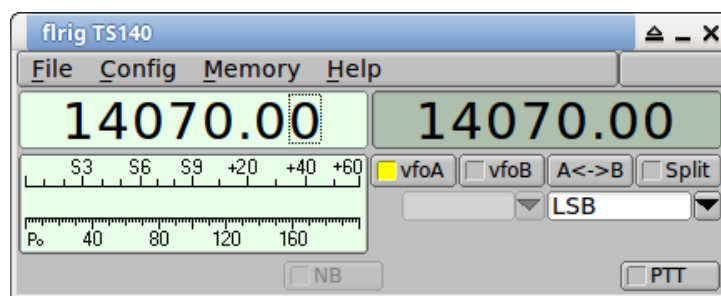

Figure 20.1 TS 140

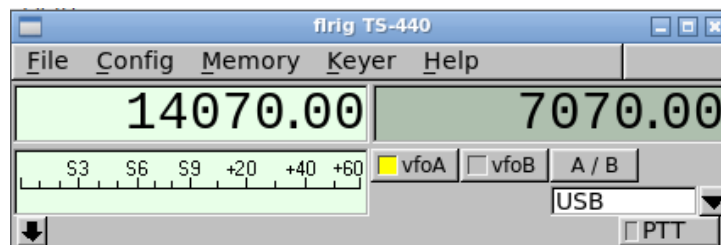

Figure 20.2 TS 440

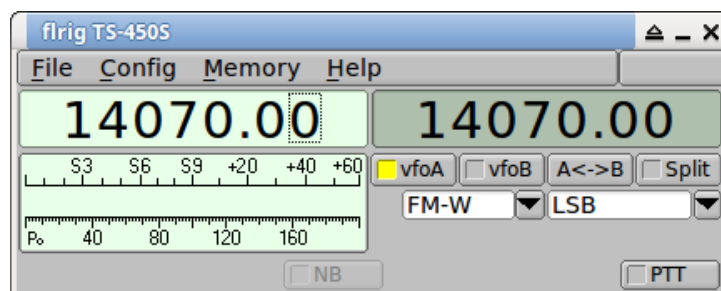

Figure 20.3 TS 450S

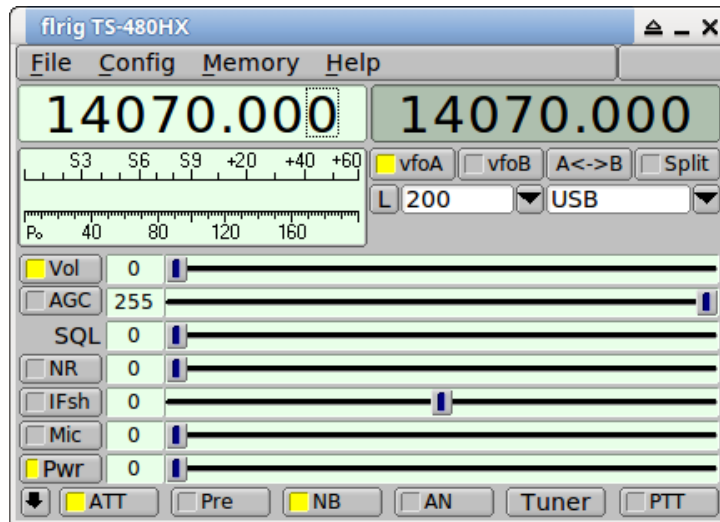

Figure 20.4 TS 480HX

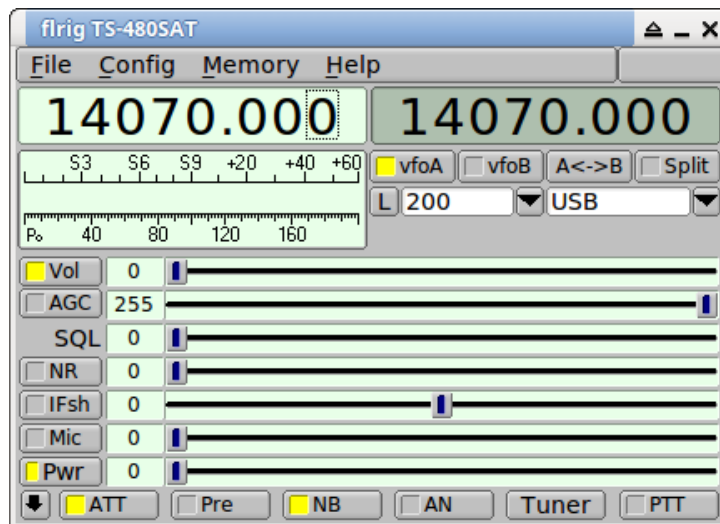

Figure 20.5 TS 480SAT

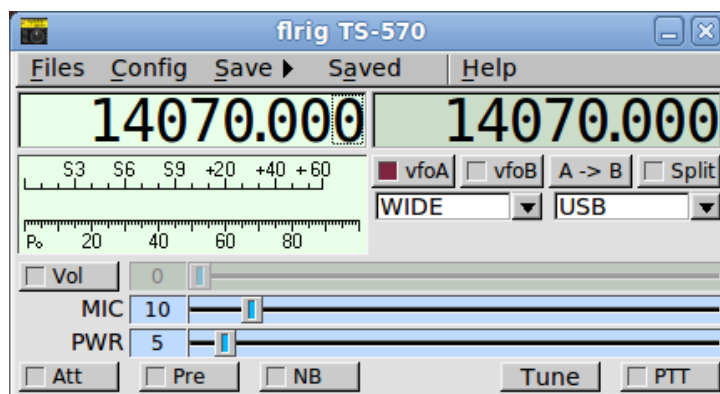

Figure 20.6 TS 570

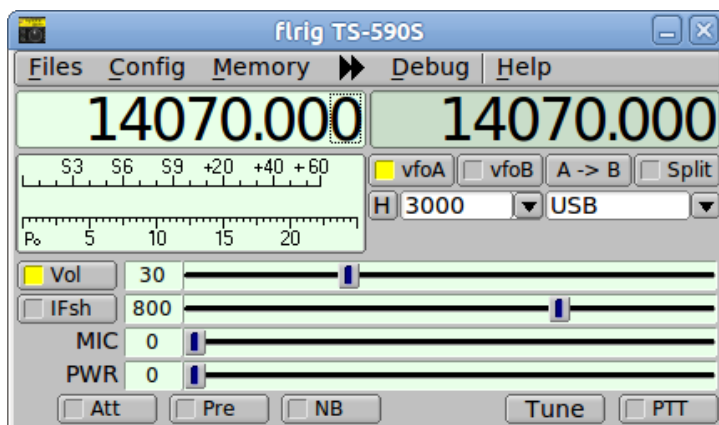

Figure 20.7 TS 590S

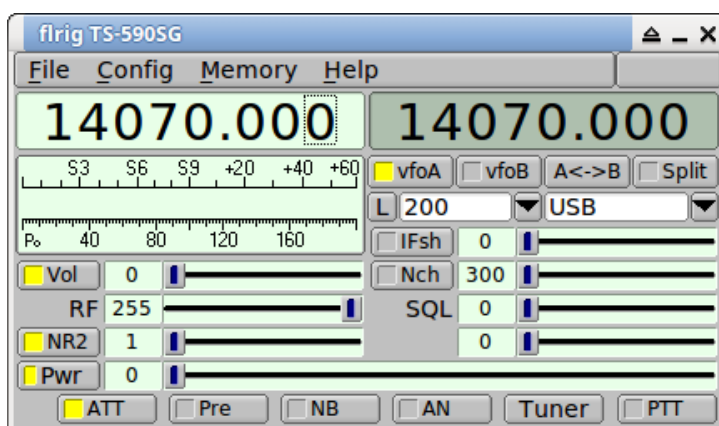

Figure 20.8 TS 590SG

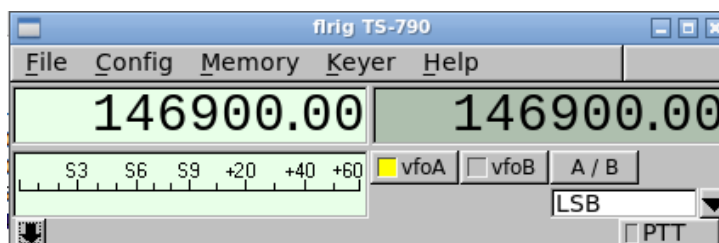

Figure 20.9 TS 790

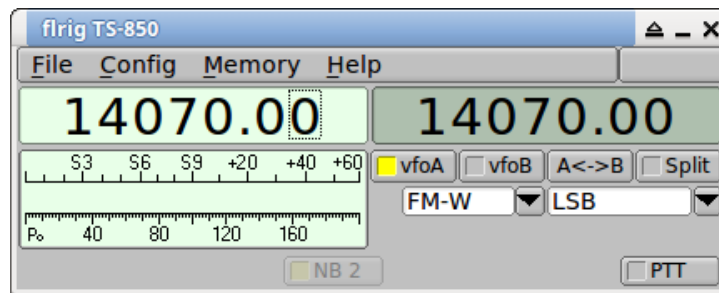

Figure 20.10 TS 850

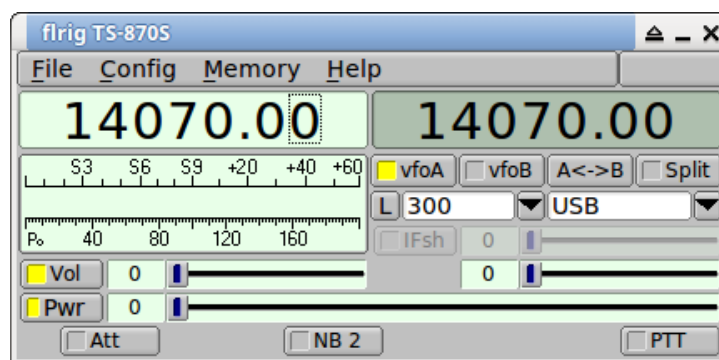

Figure 20.11 TS 870S

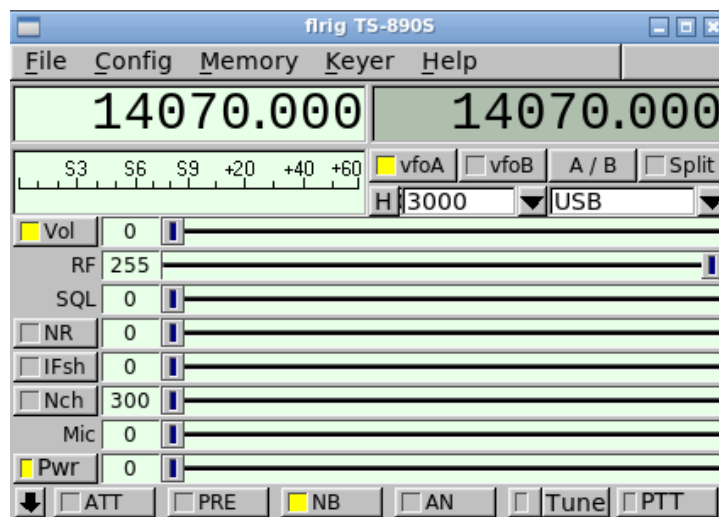

Figure 20.12 TS 890S

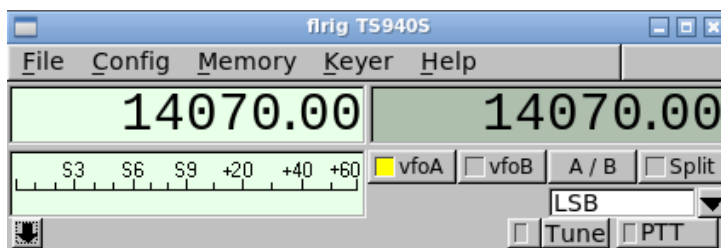

Figure 20.13 TS 940S

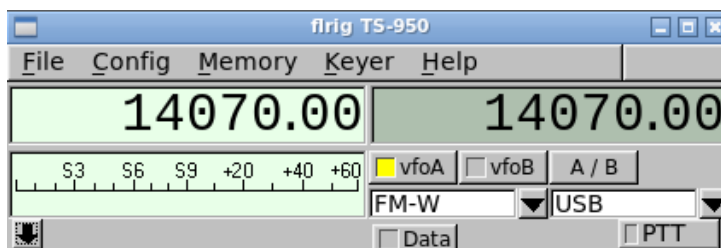

Figure 20.14 TS 950

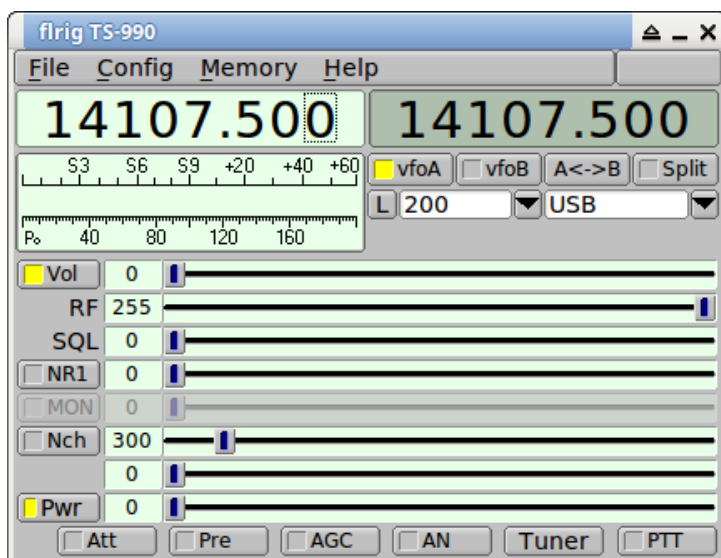

Figure 20.15 TS 990

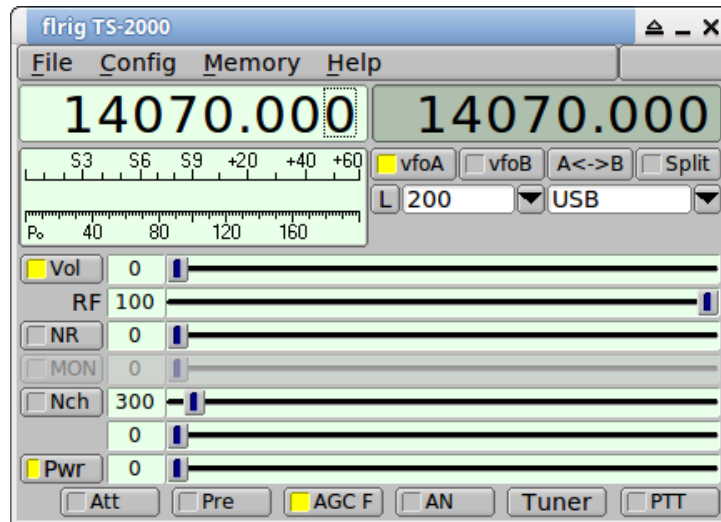

Figure 20.16 TS 2000

[Page Top Return to Contents](#)



# Chapter 21

## Supported TenTec Transceivers

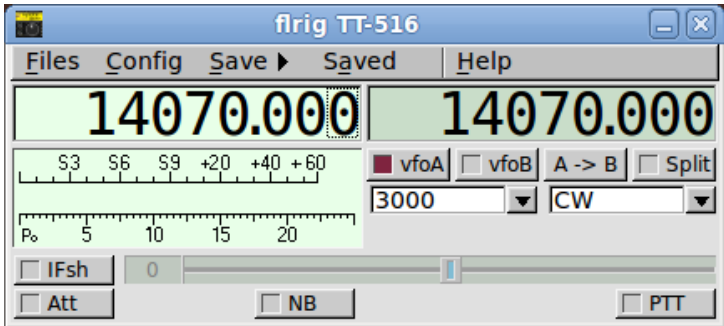

Figure 21.1 TT 516

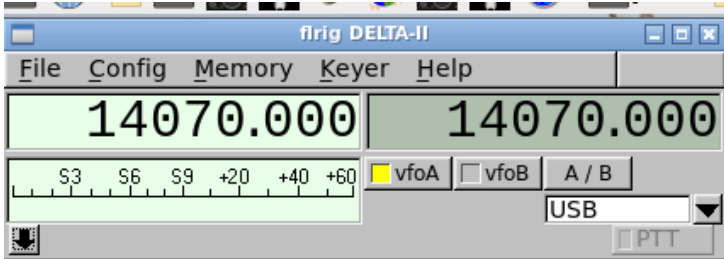

Figure 21.2 TT DELTA-II

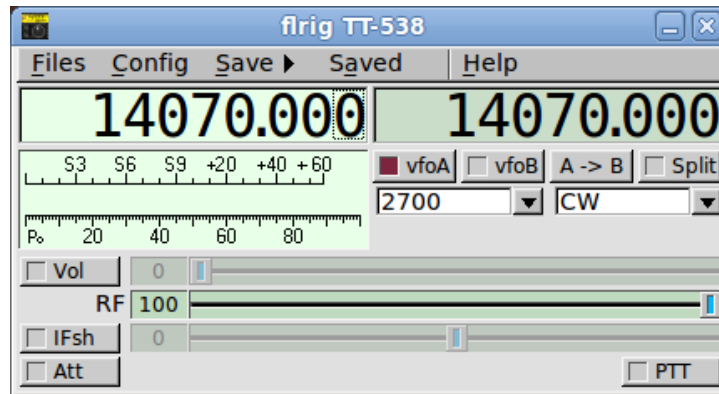

Figure 21.3 TT 538

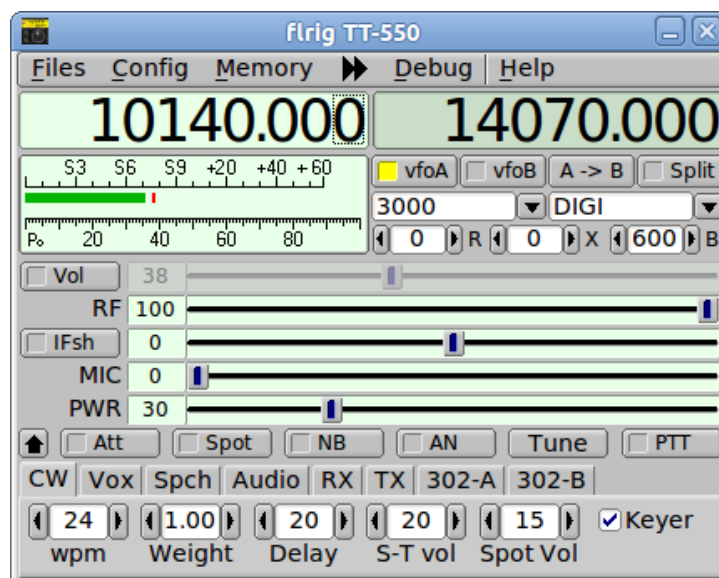

Figure 21.4 TT 550

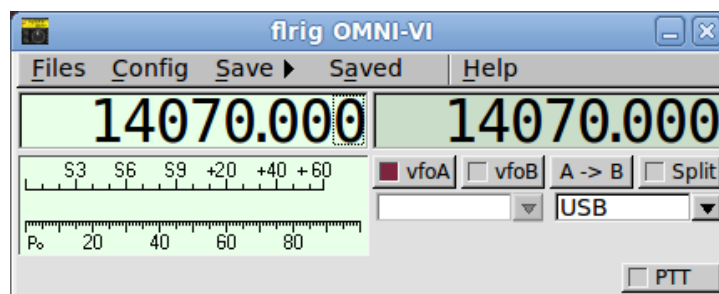

Figure 21.5 Omni VI

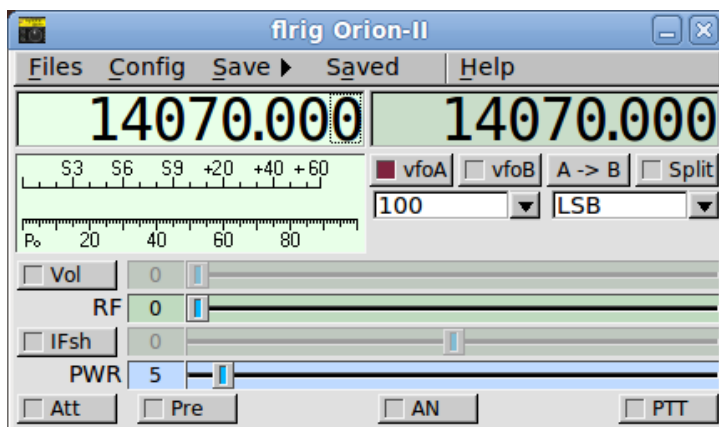

Figure 21.6 TT Orion-II

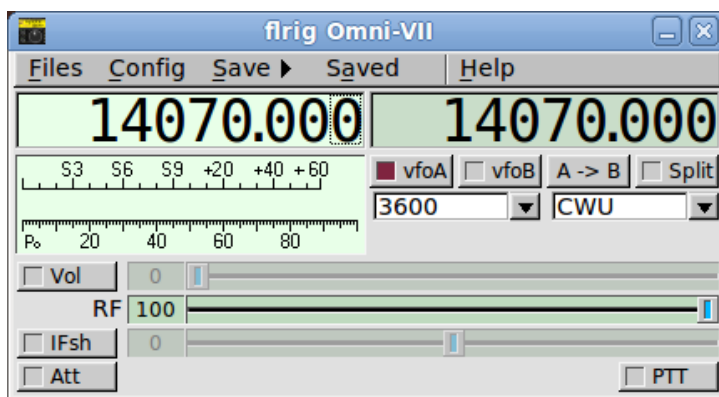

Figure 21.7 Omni VII

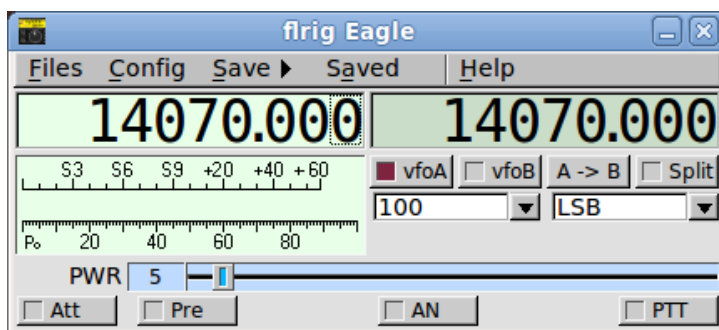

Figure 21.8 TT Eagle



# Chapter 22

## Supported Yaesu Transceivers

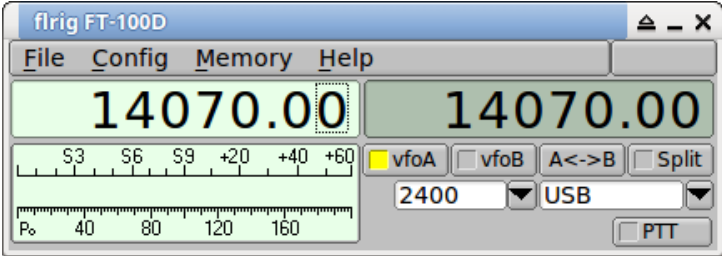

Figure 22.1 FT 100D

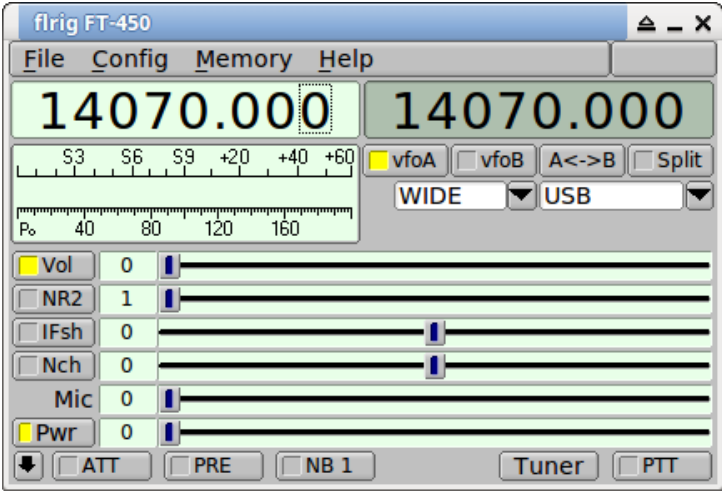

Figure 22.2 FT 450

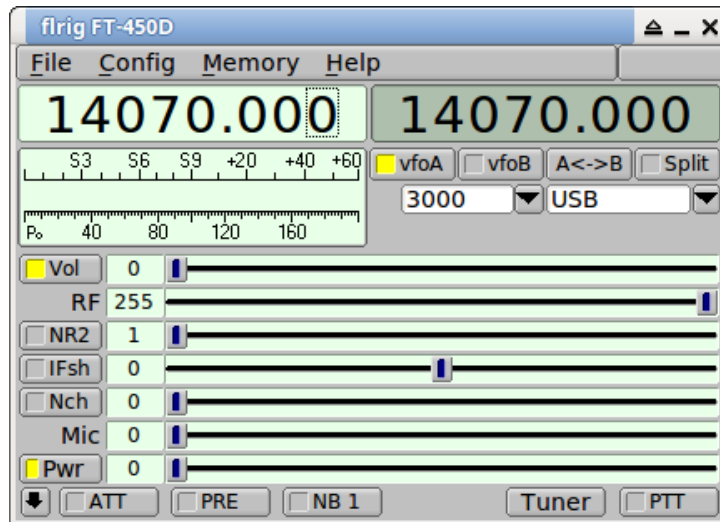

Figure 22.3 FT 450D

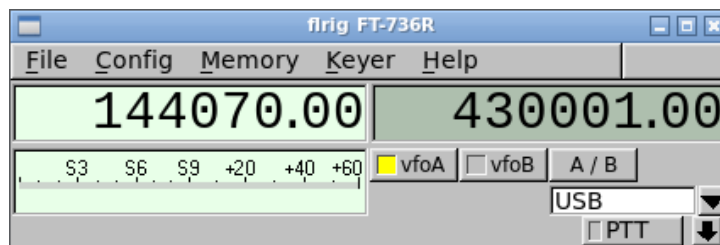

Figure 22.4 FT-736R

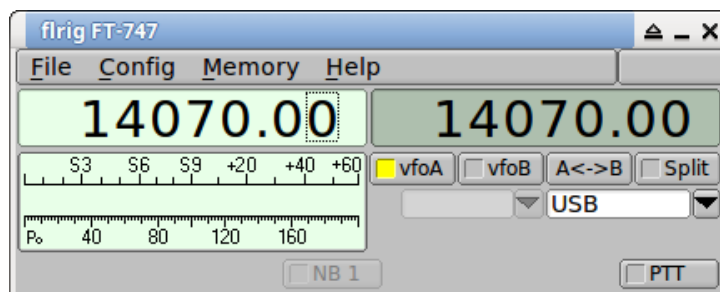

Figure 22.5 FT-747

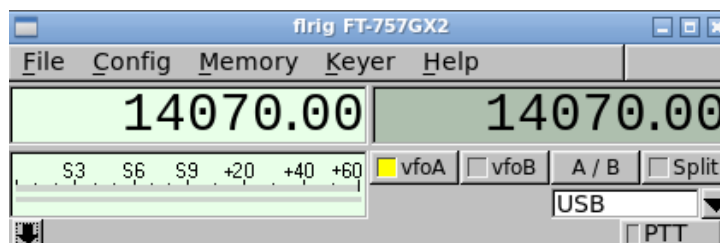

Figure 22.6 FT-757GX2

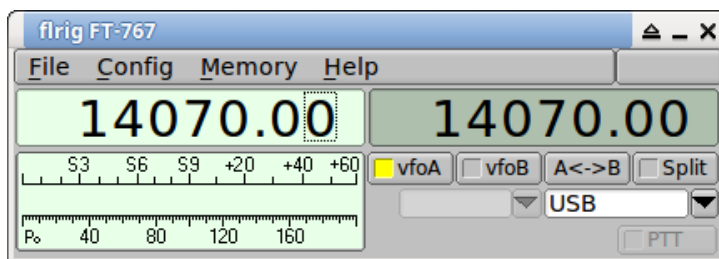

Figure 22.7 FT-767

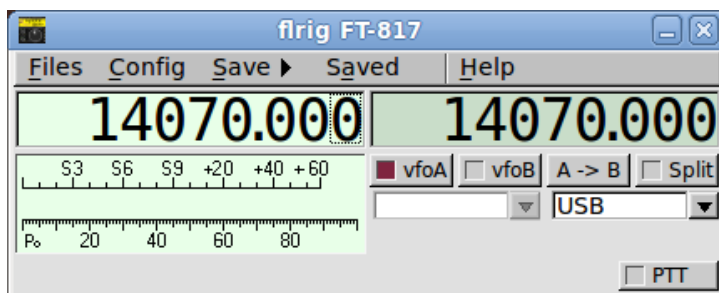

Figure 22.8 FT-817

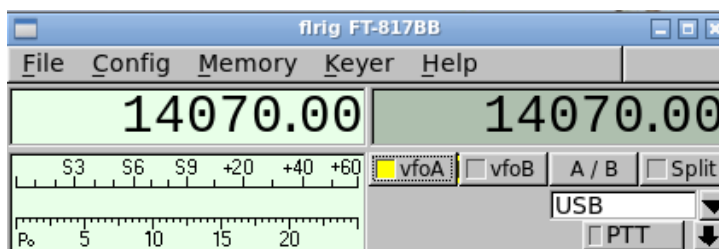

Figure 22.9 FT-817BB

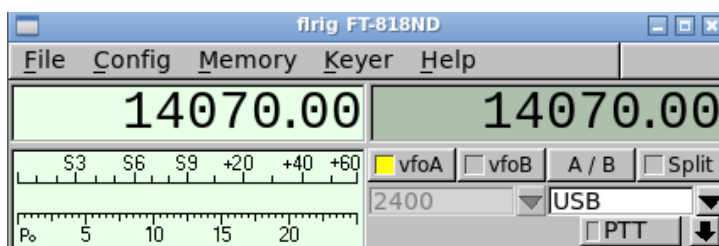

Figure 22.10 FT-818ND

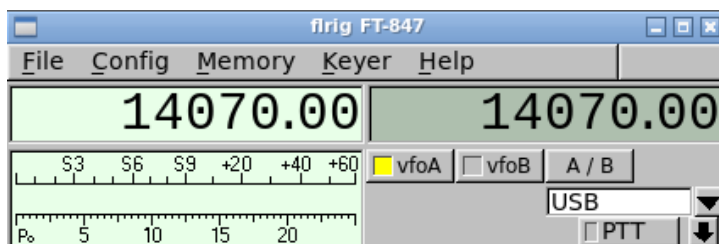

Figure 22.11 FT-847

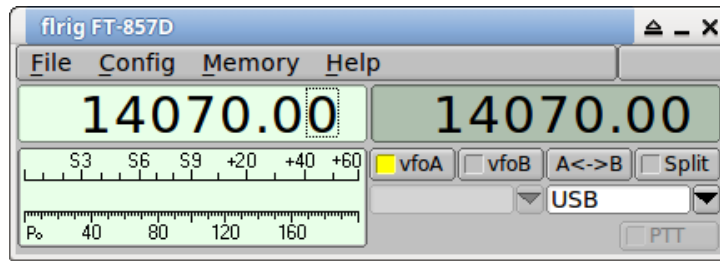

Figure 22.12 FT-857D

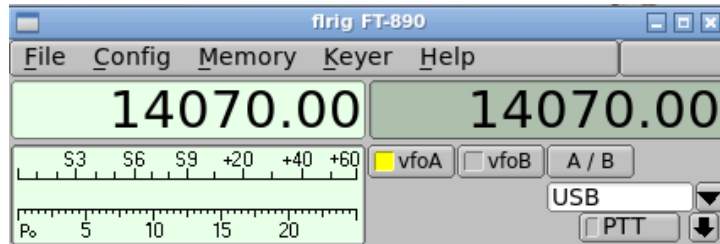

Figure 22.13 FT-890

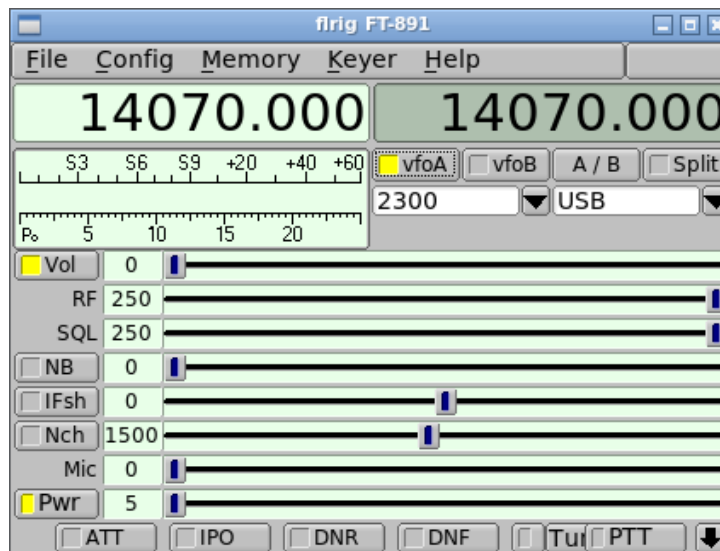

Figure 22.14 FT-891

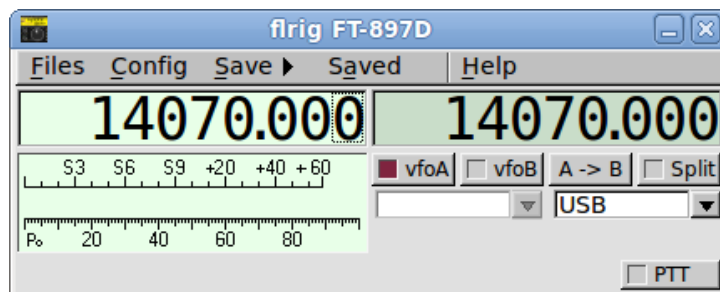

Figure 22.15 FT-897D



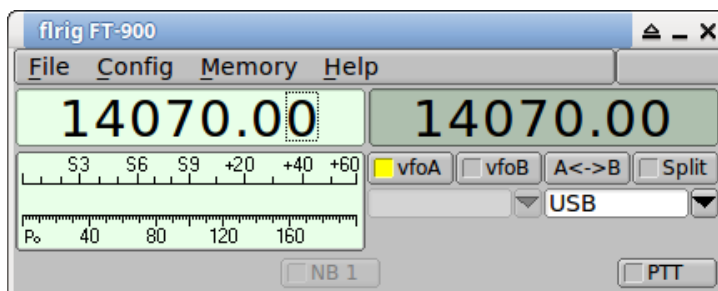

Figure 22.16 FT-900

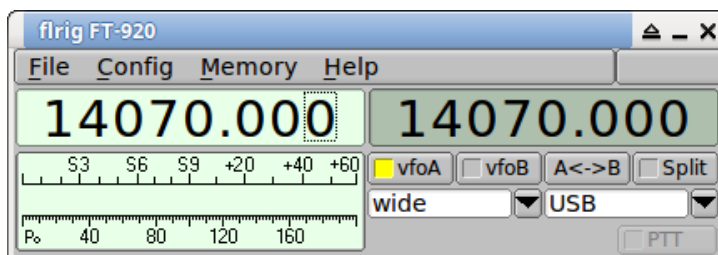

Figure 22.17 FT-920

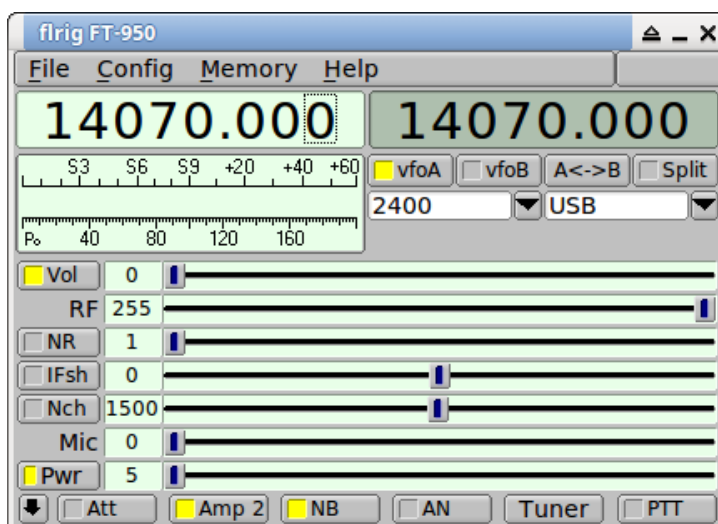

Figure 22.18 FT-950

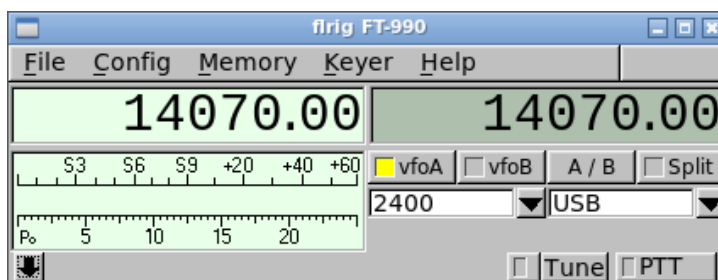

Figure 22.19 FT-990

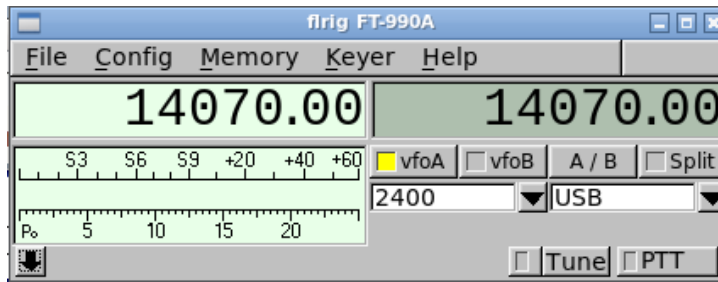

Figure 22.20 FT-990A

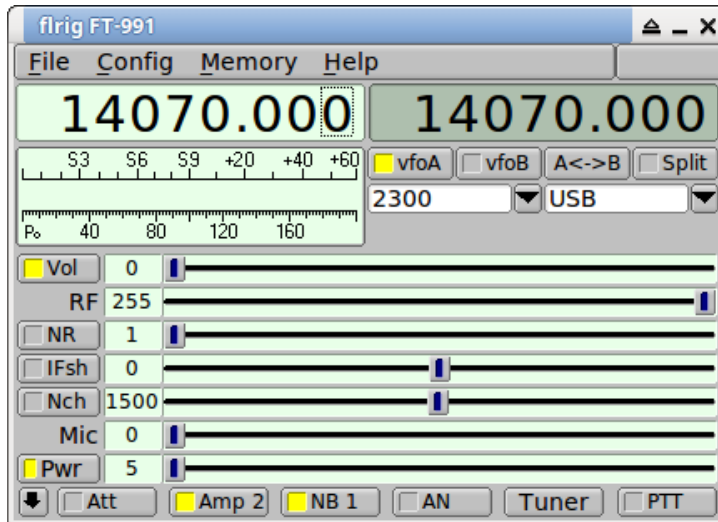

Figure 22.21 FT-991



Figure 22.22 FT-991A

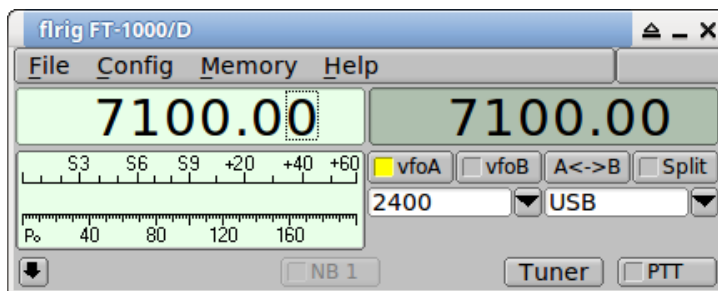

Figure 22.23 FT-1000D

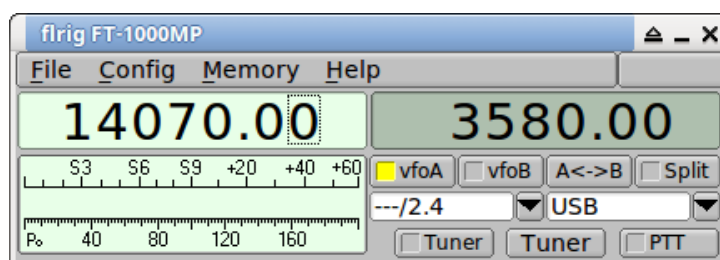

Figure 22.24 FT-1000MP

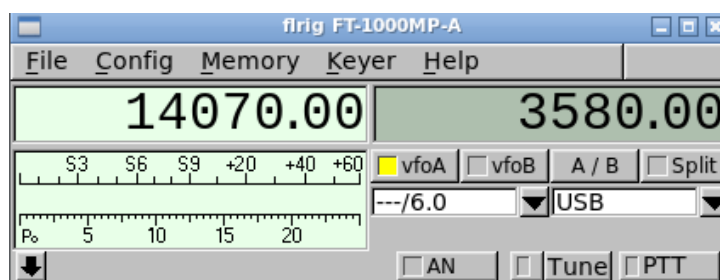

Figure 22.25 FT-1000MP-A

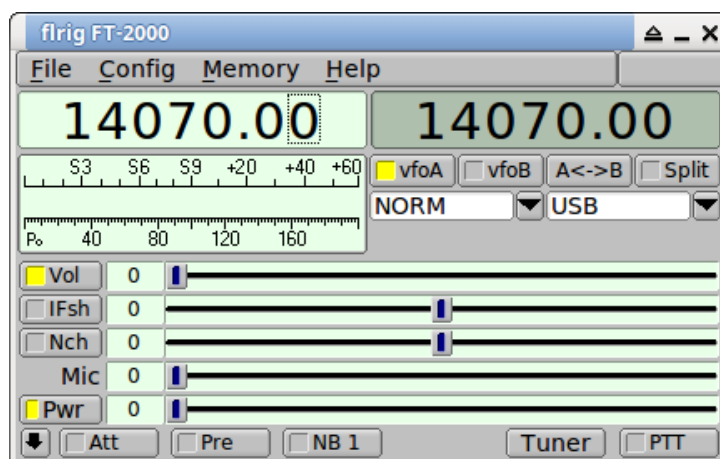

Figure 22.26 FT-2000

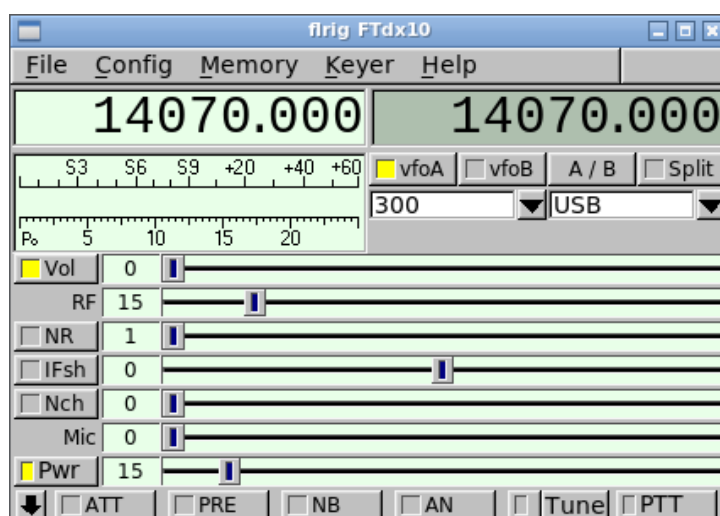

Figure 22.27 FTdx10

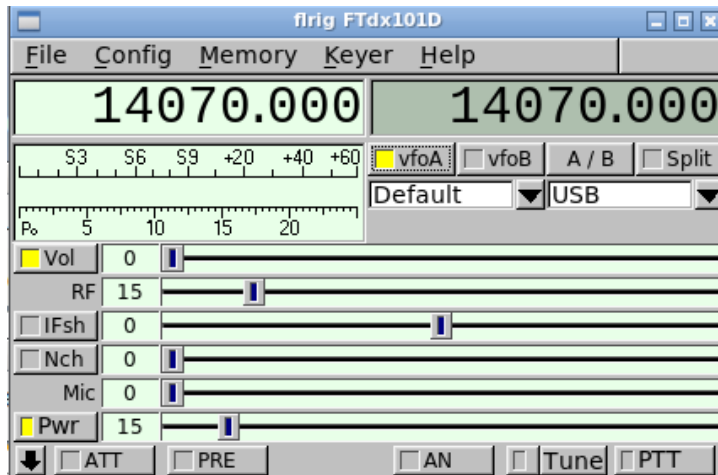

Figure 22.28 FTdx101D

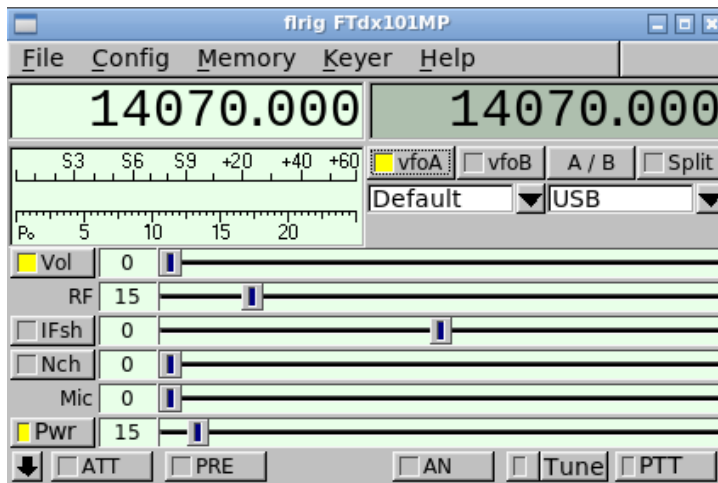

Figure 22.29 FTdx101MP

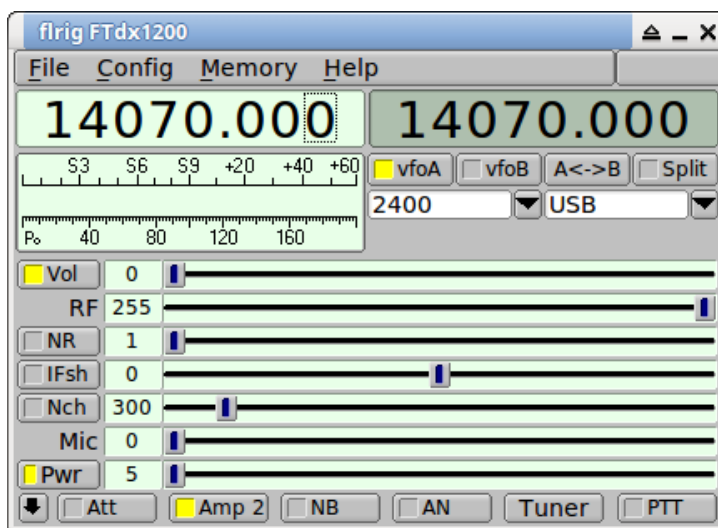

Figure 22.30 FT-dx1200

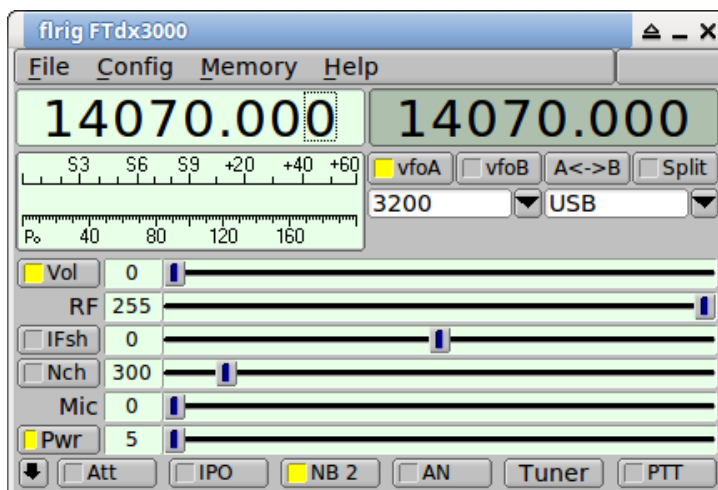

Figure 22.31 FT-dx3000

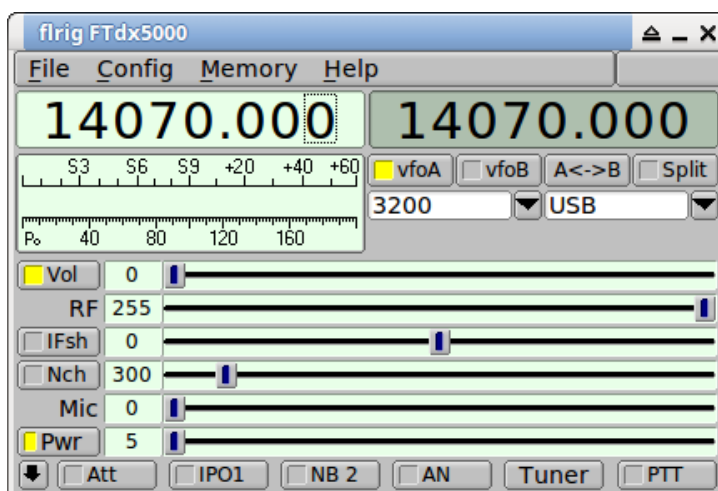

Figure 22.32 FT-dx5000

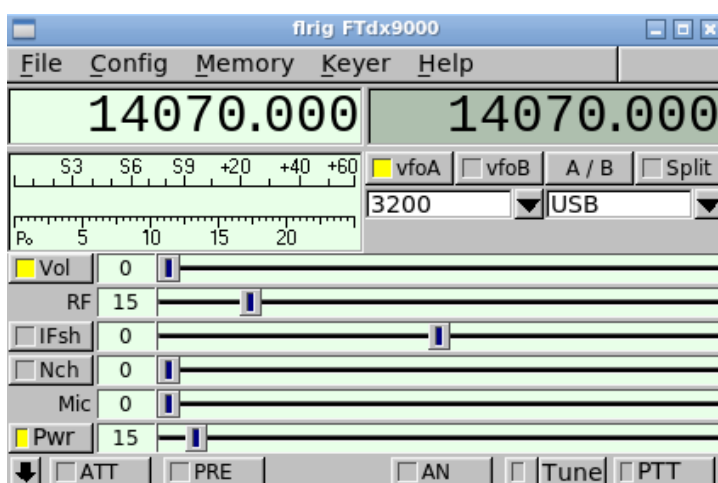

Figure 22.33 FTdx9000



# Chapter 23

## Other Supported Transceivers

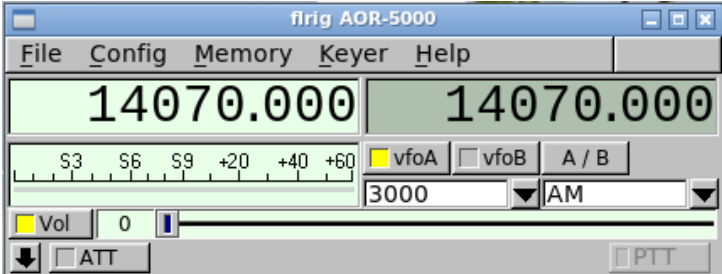

Figure 23.1 AOR5000

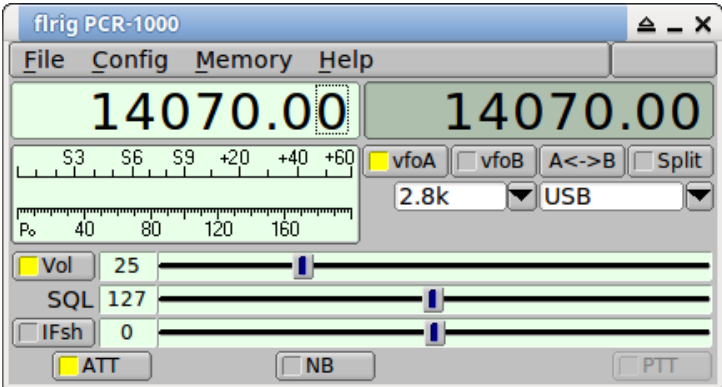

Figure 23.2 PCR 1000

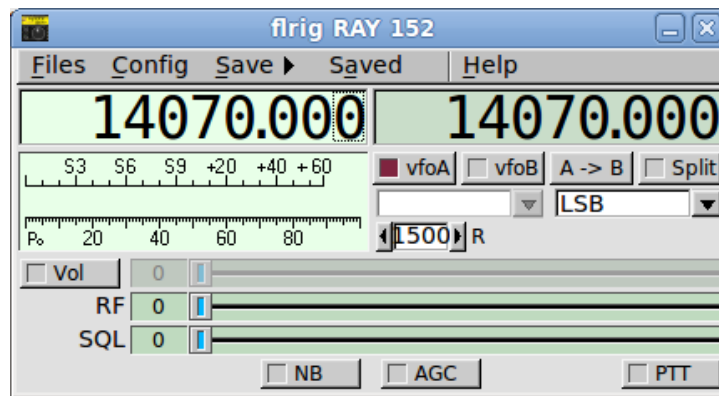

Figure 23.3 RAY 152

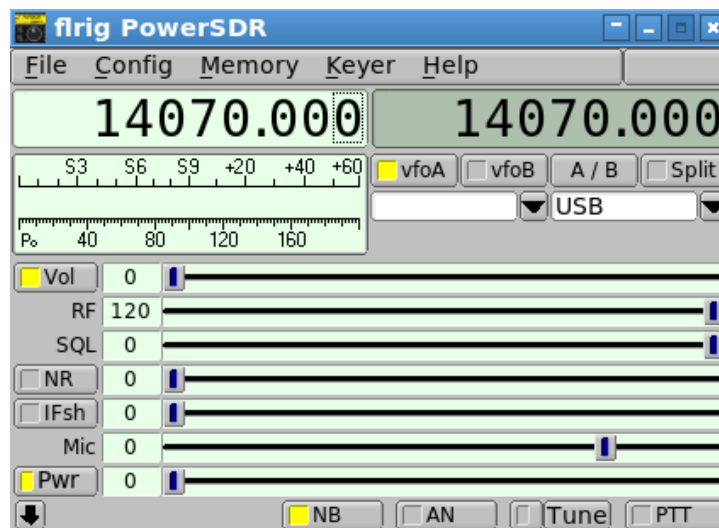

Figure 23.4 Power SDR

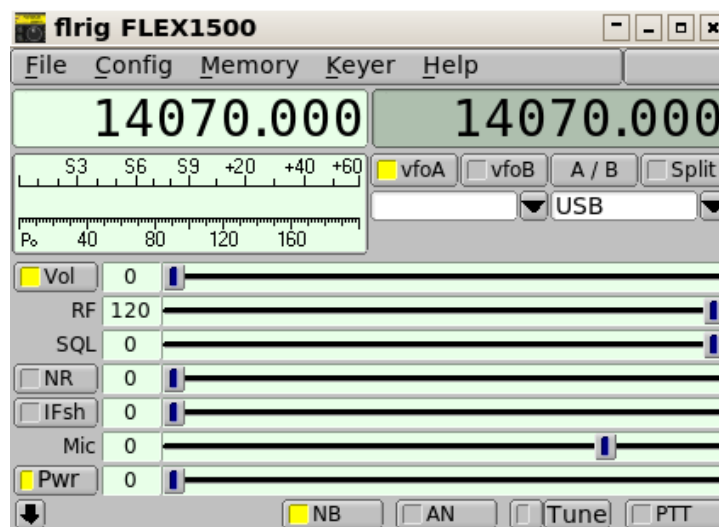

Figure 23.5 Flex 1500



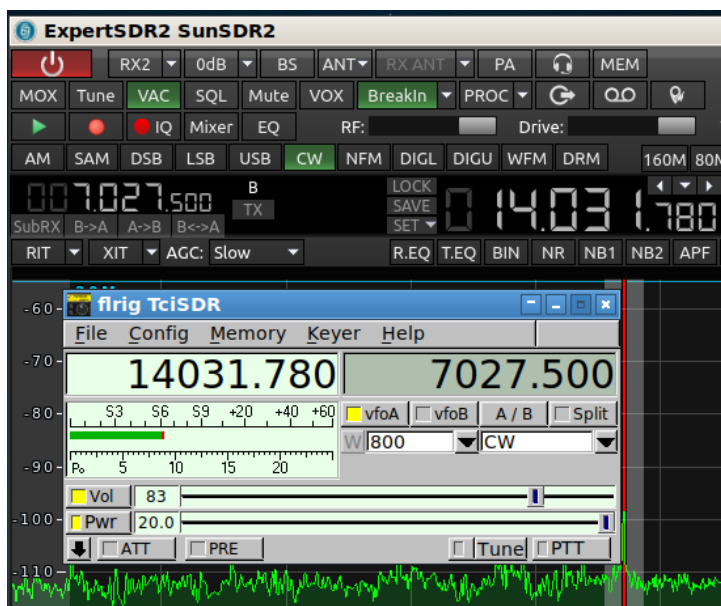

Figure 23.6 SunSDR2 Pro

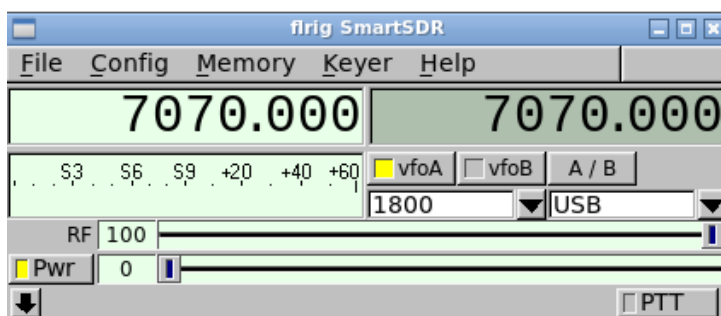

Figure 23.7 SmartSDR

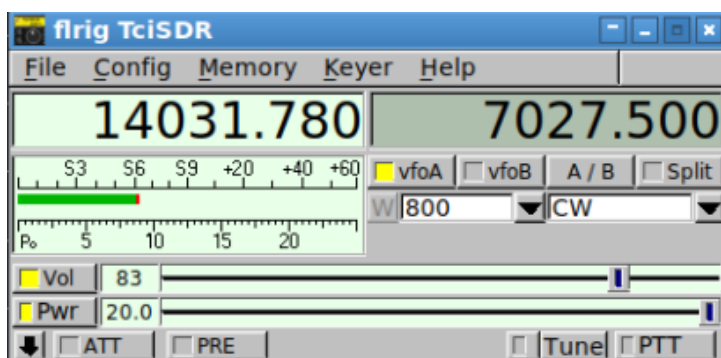

Figure 23.8 TCISDR

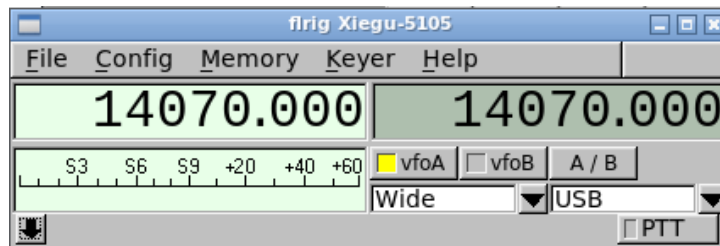

Figure 23.9 Xiegu-5105



Figure 23.10 Xiegu-G90

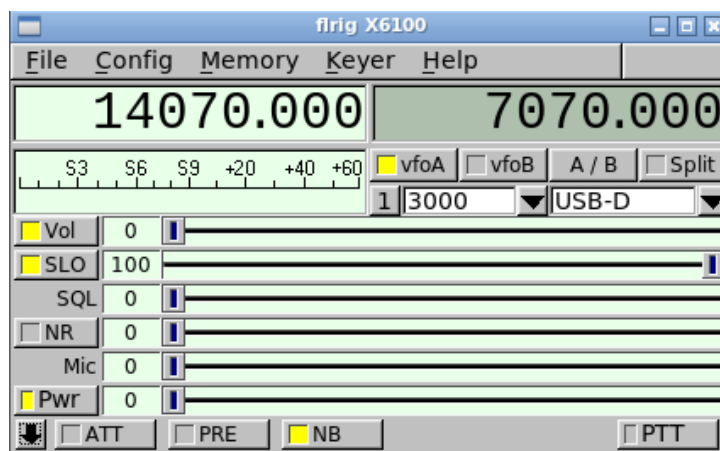

Figure 23.11 X6100

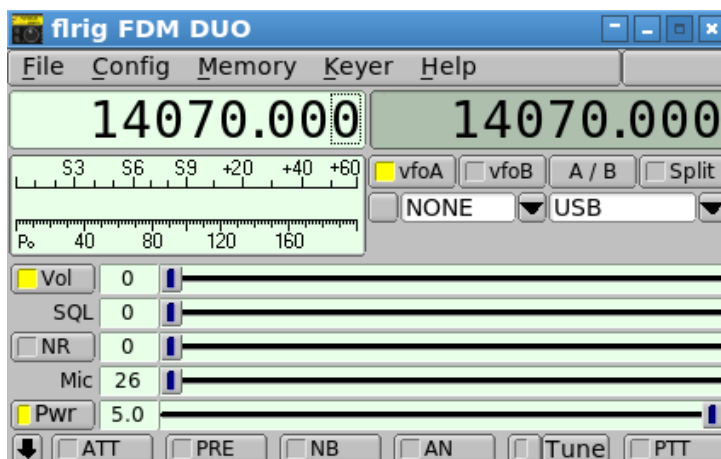

Figure 23.12 FDM-DUO

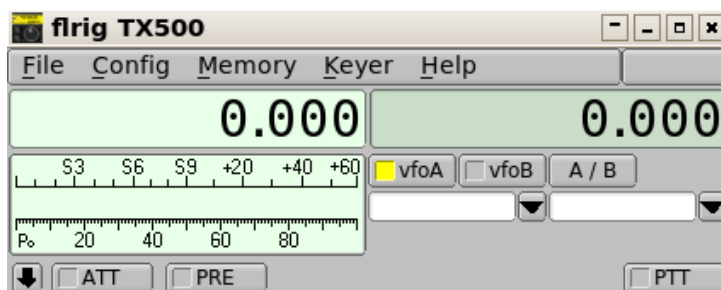

Figure 23.13 Lab599 TX500

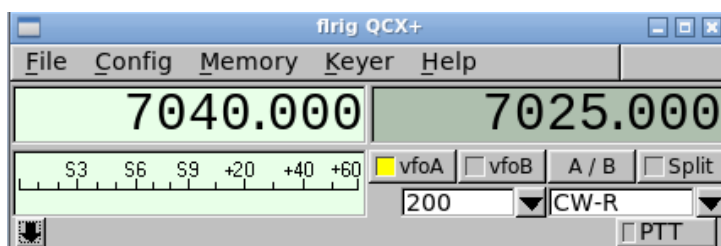

Figure 23.14 QCX+

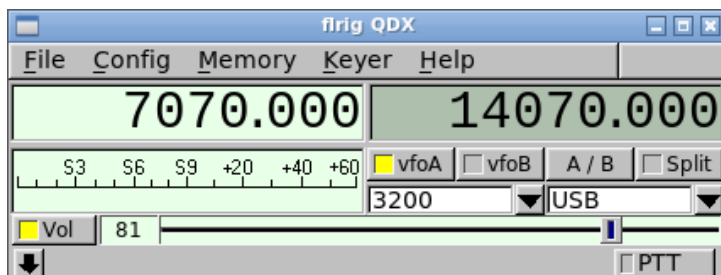

Figure 23.15 QDX

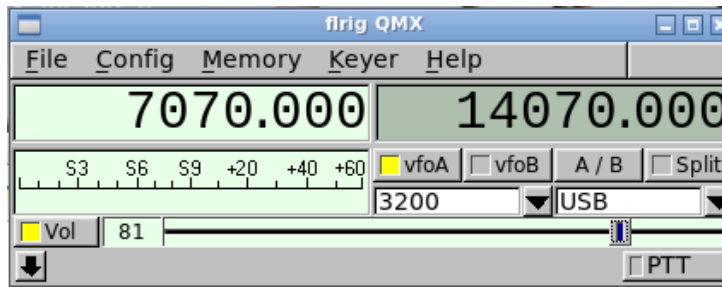

Figure 23.16 QMX

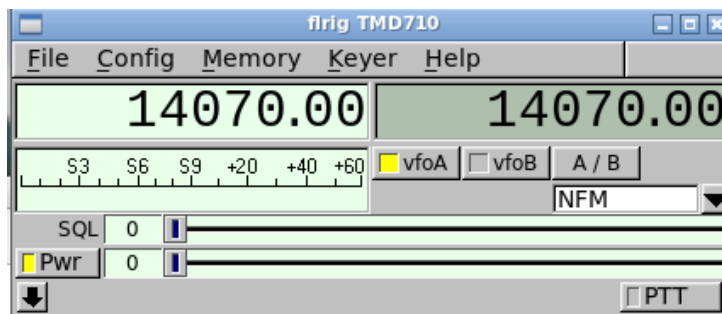

Figure 23.17 TMD710

[Page Top Return to Contents](#)

# Chapter 24

## FT-991A setup

CAT control involves both software and settings on the radio itself. The default radio settings on the FT-991A are not likely to work “out of the box”.

Some initial things to verify are in place:

- Download and install the USB driver for the radio. NOTE: be sure the USB cable is UNPLUGGED from the computer when you install the driver regardless of the OS your are using.
  - If you’re using Windows get the driver from [Yaesu](#).
  - If using Linux or MacOS then get the drivers direct from [Silicon Labs](#). Some versions of Linux have a driver built in.
  - For MacOS High Sierra and later be sure to go to Security & Privacy in the System Configuration settings and in the General tab allow the driver to be accessed. Without doing that it will be unusable.
- Download the latest version of [Fldigi](#). Flrig is written as a companion to fldigi and adds much greater rig control than is possible with just fldigi. It is especially good with the FT991A. I basically only touch the radio to turn it on or off when running digital modes, and even that can be automated.

### 24.1 Transceiver setup

#### 24.1.1 FT-991A Menu Settings

On the rig, press the MENU button. Then change these menu items as shown:

Menu #	Name	Value
31	CAT RATE	38400 bps
32	CAT TOT	10 msec
33	CAT RTS	ENABLE
59	CW FREQ DISPLAY	PITCH OFFSET
60	PC KEYING	DTR
62	DATA MODE	OTHERS
63	PSK TONE	1500 hZ
64	OTHER DISP (SSB)	1500 Hz
65	OTHER SHIFT (SSB)	1500 Hz
66	DATA LCUT FREQ	300 Hz

Menu #	Name	Value
67	DATA LCUT SLOPE	18 dB/oct
68	DATA HCUT FREQ	3600 Hz
69	DATA HCUT SLOPE	18 dB/oct
70	DATA IN SELECT	REAR
71	DATA PTT SELECT	DAKY
72	DATA PORT SELECT	USB
73	DATA OUT LEVEL (RX)	100
74	FM MIC SELECT (PHONE)	MIC
75	FM OUT LEVEL (Rx)	50
76	FM PKT PTT SELECT	DTR
77	FM PKT PORT SELECT	DATA
106	SSB MIC SELECT	MIC
107	SSB OUT LEVEL	50
108	SSB PTT SELECT	DAKY
109	SSB PORT SELECT	USB
110	SSB TX BPF	300-2700
114	IF NOTCH WIDTH	NARROW
146	DATA VOX GAIN	50
147	DATA VOX DELAY	100 msec
148	ANTI DVOX GAIN	0

You should have already installed the driver for the built-in sound card in the FT-991A.

Connect the rig to the computer with a USB A-Male to B-Male cable and turn on the radio.

### 24.1.2 Initial Setup

With the radio on and the USB cable connected and no other communications program running, Start flrig. It will come up with just a basic display.

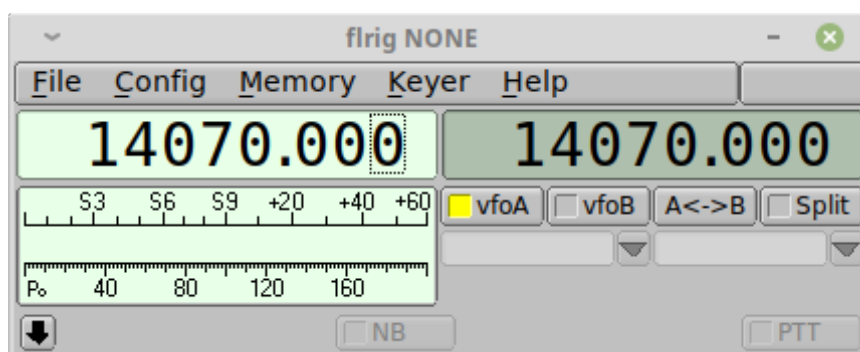

Figure 24.1 Initial Flrig Dialog

Open the menu *Config/Setup/Transceiver*.

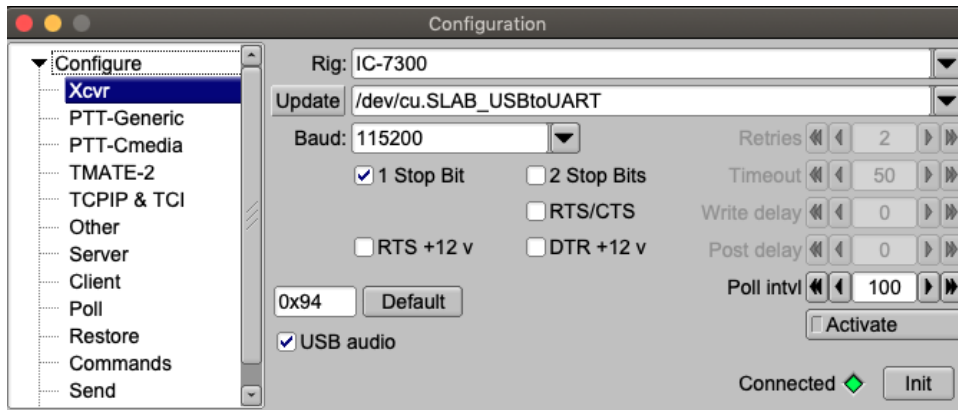

Figure 24.2 Select FT991A

Choose the FT991A from the Rig dropdown list. That will select the default settings which will work on . Note: The RTS +12v and DTR +12v boxes do not normally need to be checked.

**24.1.3 Select the Serial Port to use:**

- Mac / Linux - Select the SilconLabs driver from the dropdown list. If it isn't in the list then click the SerPort button to repopulate the list. If it still isn't in the list then the driver is not loading for some reason like the radio is not on or connected or the driver has not been installed properly so that needs to be rectified before going on. If you're using MacOS High Sierra or a later version of MacOS you may need to authorize the driver install in Security & Privacy setup in System Preferences after running the install program. There will be a message on the General page if it has been blocked.
- 
- Windows - Open the device manager and determine to which com port the serial driver from Silcon Labs is assigned and choose that from the drop down list. Verify that the Baud rate in flrig matches the baud rate selected in the rig. It's better to choose a fixed baud rate than Auto. Now, click the Init button. It should go from red to black lettering. If it does not go to black lettering then verify all of the above again, especially baud rate and echo.
- Flrig now should have control of the rig so changing frequency in flrig will changed the frequency on the rig and visa versa. The buttons and sliders should do as they are labeled.

**24.1.4 Restore tab:**

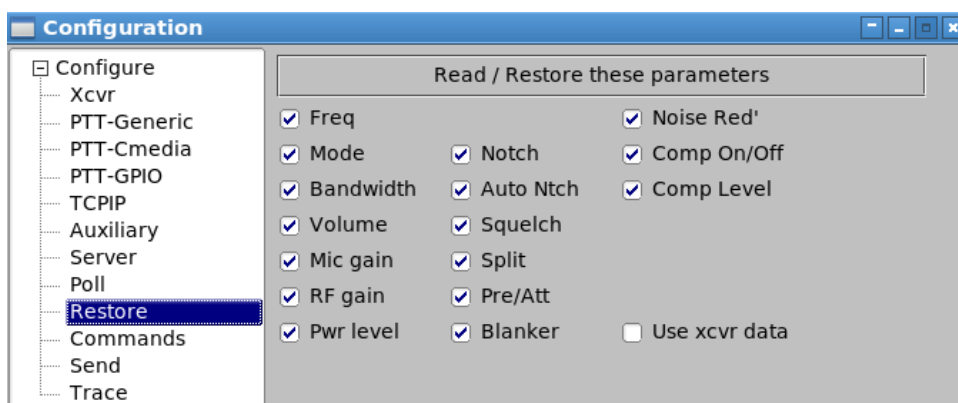

and choose whether you want flrig to save and restore all the radio's parameters on startup and exit or whether you want it to open with the same settings as the rig is currently using. If Use xcvr data is checked flrig will start up with the same settings as the rig currently is using.

### 24.1.5 Poll tab

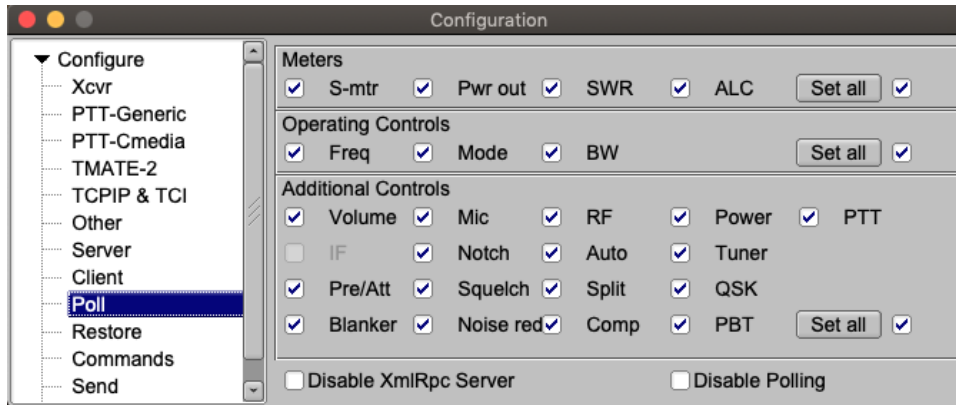

and click the Set All buttons for the initial polling options.

I would recommend before you move on that you go to the Config/UI menu and select Tooltips. They are a great help to the new user to figure out what each control does as not all are labeled. You can choose 4 different UI's from the narrow one with small sliders (I use this one – see above screen shot of flrig), to a narrow one with large sliders, to a wide version or a touch version. Now close flrig and restart it to be sure all is well . Everything should be working and you should be able to change frequency on the radio and flrig should follow.

## 24.2 flrig/FT991A/fldigi

Start fldigi and fill in the initial setup pages presented. You can ignore the last page for now. All these pages can be accessed via the configuration menu later to be changed as you wish. Since you've chosen to use flrig then go to the fldigi menu "Configuration/Rig control/flrig" and check the top box to tell fldigi to use flrig for rig control with fldigi as client.

Leave the other controls at their default setting.

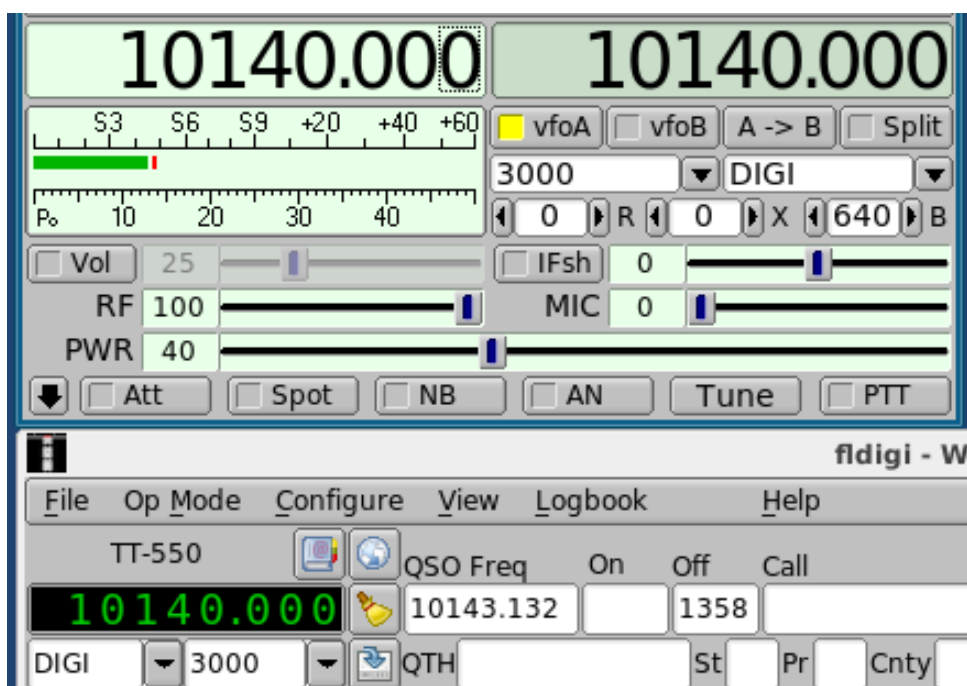



Once that is done fldigi should communicate with flrig and changes such as frequency or bandwidth in flrig or fldigi should be reflected in the other. If the lower box is checked then flrig will send fldigi audio to the radio when the PTT button is clicked otherwise PTT will just key the rig with no power out. Click Save at the bottom of the page.

All that is left is to customize fldigi for how you want to operate. Many things can be changed such as the UI scheme, colors, Macros, and many more. Read the help manual to learn about all the options and features that are available.

### 24.2.1 Final Setup

With fldigi running verify you have a blue waterfall running. If you don't see that then there is a problem with the audio input to fldigi. Verify the Soundcard setup.

Note:

- For MacOS Mojave and later you must enable the microphone for fldigi in Security & Privacy in the System Preferences settings.
- For Windows 10 be sure to grant permission for fldigi to access the Microphone.

Now we will verify the power out of the radio. Set the radio power control on the rig to max, 100% and leave it there.

Set Power Meter scale: Right click on the lower portion of the S-meter scale and choose the power scale desired. The max digital power out used for a QSO should cause no ALC action on the radio. The FT991A will put out quite a bit of power without ALC action, but you don't want to interfere with other close signals on the band either so ideally the power should be between 25-40 watts.

[Return to Contents](#)



# Chapter 25

## IC-7100 Setup

### 25.1 IC 7100 menu setup

Press the transceiver SET button then the on screen item: then Connectors.

Make sure the settings for these items are as follows:

- USB Audio SQL - OFF
- ACC/USB Output Select - AF
- ACC/USB AF Level - 50%
- ACC/USB IF Level - 50%
- ACC MOD Level - 20%
- DATA MOD Level - 100%
- USB MOD Level - 10%
- DATA OFF MOD - MIC, ACC
- DATA MOD - USB
- CI-V
  - Baud Rate - 19,200
  - Address - 88h
  - Transceive - OFF
  - Output (for ANT) - OFF
  - USB Port - Unlink from REMOTE
- FUNCTION
  - Monitor - ON
  - Monitor Level - 50%
  - Beep Level - 50%
  - CW Normal Side - USB

## 25.2 flrig setup

You should have already installed the driver for the built-in sound card in the 7100.

Connect the transceiver to the computer with a USB A-Male to B-Male cable and turn on the radio.

### 25.2.1 Install flrig.

For Windows flrig will install to it's own folders and should be installed in the normal application folder where other applications are installed.

Putting them in other folders can causes permissions issues sometimes on Windows 10. For Mac and Linux install them as you would any other application.

With the radio on and the USB cable connected and no other communications program running, Start flrig.

It will come up with just a basic display.

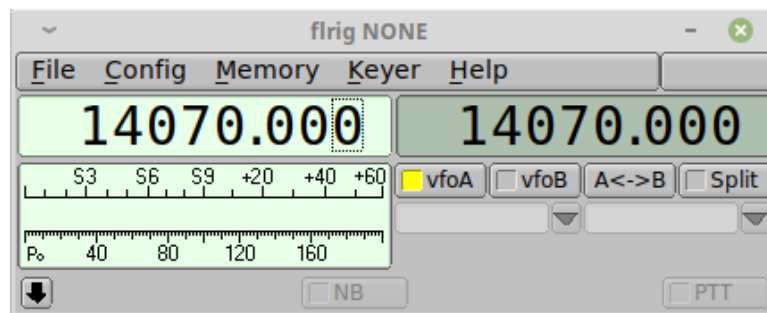

Figure 25.1 Initial Flrig Dialog

Go to the menu Config/Setup/Transceiver.

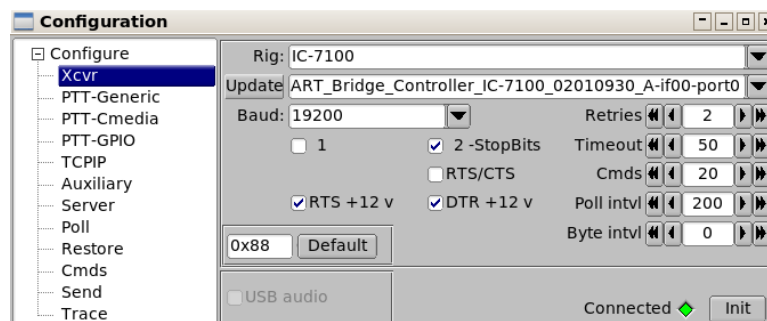

Figure 25.2 Select IC7100

Choose the 7100 from the Rig dropdown list. That will select the default settings which will be good for starters. Note: The RTS +12v and DTR +12v boxes do not need to be selected.

Select the Serial Port to use

- Windows - select the correct COM port
- Mac/Linux - Select the SilconLabs driver from the dropdown list.

If the device does not appear in the list then click the SerPort button to repopulate the list. If it still isn't in the list then the driver is not loading for some reason like the radio is not on or connected or the driver has not been installed properly so that needs to be rectified before going on. If you're using MacOS High Sierra or a later version of MacOS you may need to authorize the driver install in Security & Privacy setup in System Preferences after running the install program. There will be a message on the General page if it has been blocked.

Windows:

Open the device manager and determine to which com port the serial driver from Silcon Labs is assigned and choose that from the drop down list. Verify that the Baud rate in flrig matches the baud rate selected in the rig. It's better to choose a fixed baud rate than Auto. Now, click the Init button. It should go from red to black lettering. If it does not go to black lettering then verify all of the above again, especially baud rate.

### 25.2.2 Restore xcvr parameters

Select the restore tab

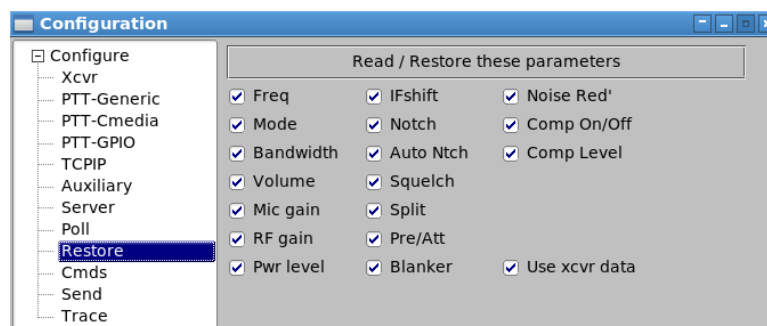

Figure 25.3 Restore IC7100 Settings

and choose whether you want flrig to save and restore all the radio's parameters on startup and exit or whether you want it to open with the same settings as the rig is currently using. If Use xcvr data is checked flrig will start up with the same settings as the rig currently is using.

### 25.2.3 Select the Poll tab

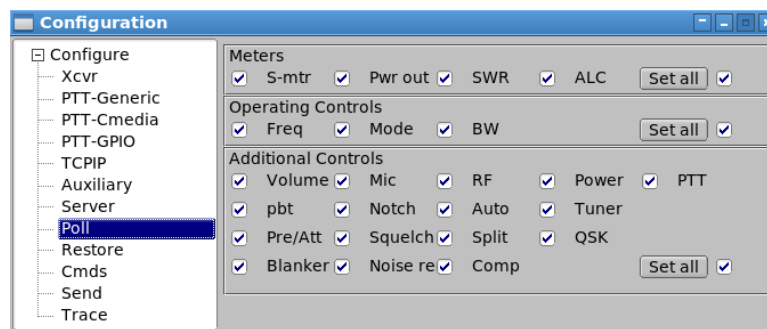

Figure 25.4 IC7100 Polling Settings

and select to poll all of the parameters.

flrig now should have control of the rig so changing frequency in flrig will change the frequency on the rig and visa versa. The buttons and sliders should do as they are labeled.

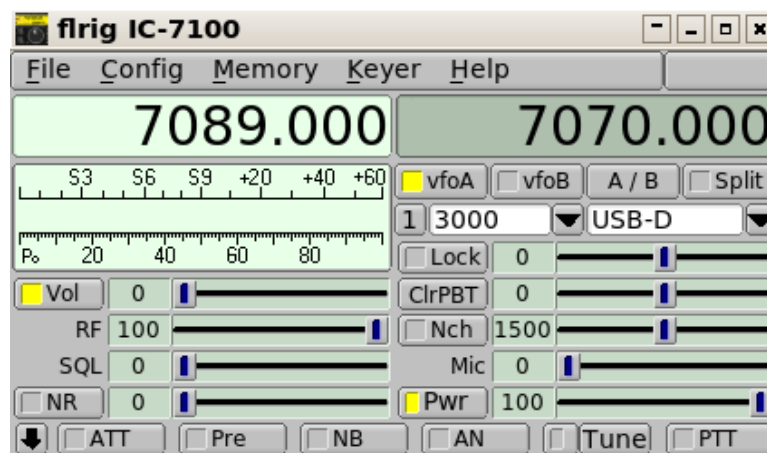

Figure 25.5 IC7100 Main Dialog

I would recommend before you move on that you go to the Config/UI menu and select Tooltips. They are a great help to the new user to figure out what each control does as not all are labeled. You can choose 4 different UI's from the narrow one with small sliders (I use this one – see above screen shot of flrig), to a narrow one with large sliders, to a wide version or a touch version. Now close flrig and restart it to be sure all is well. Everything should be working and you should be able to change frequency on the radio and flrig should follow.

Page Top

[Return to Contents](#)

# Chapter 26

## IC-7300 Setup

### 26.1 IC 7300 menu setup

Press the transceiver MENU button then the on screen items: Set , then Connectors.

Make sure the settings for these items are as follows:

- USB SEND - Off
- USB Serial function - CI-V
- Data Mod - USB
- Data Off Mod - Mic, ACC or just Mic if you wish. This applies only when the rig is not in data mode.
- USB MOD Level - I have mine set at 28% so you might try this for starters. This is the input level control for the TX sound from the computer. How to fine tune it will be explained later.
- ACC/USB AF Beep/Speech level - Off
- ACC/USB AF SQL - Off
- ACC/USB AF Output level - I have mine set at 80%. This is the built-in soundcard in the radio output level that goes into fldigi on receive. Too much and you overdrive fldigi and decoding suffers, too little and you may miss weak signals though fldigi does very well with very weak signals. Something to play with to make it work best for you. See the fldigi manual on setting up the sound levels.
- ACC/USB Output Select - AF

Once the above are set then touch the CI-V line on screen to get a list of items to set especially for CAT control. Many of these are ok at default, but verify the ones listed below:

- CI-V address - 94h
- CI-V Transceive - Off
- CI-V USB Port - Unlink from REMOTE
- CI-V USB Baud Rate - 19,200. I use 115,200, but use 19,200 for starters as that is what flrig defaults to. Response will be a bit quicker with higher rates, but it will do well at 19,200 also.
- CI-V USB Echo Back – On. On is only needed for compatability with other software. Flrig does not need it on so if only using flrig then set to Off.

## 26.2 flrig setup

You should have already installed the driver for the built-in sound card in the 7300.

Connect the transceiver to the computer with a USB A-Male to B-Male cable and turn on the radio.

### 26.2.1 Install flrig.

For Windows flrig will install to it's own folders and should be installed in the normal application folder where other applications are installed.

Putting them in other folders can causes permissions issues sometimes on Windows 10. For Mac and Linux install them as you would any other application.

With the radio on and the USB cable connected and no other communications program running, Start flrig.

It will come up with just a basic display.

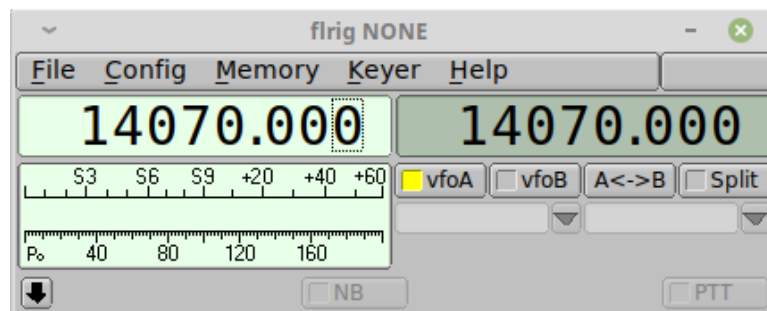

Figure 26.1 Initial Flrig Dialog

Go to the menu Config/Setup/Transceiver.

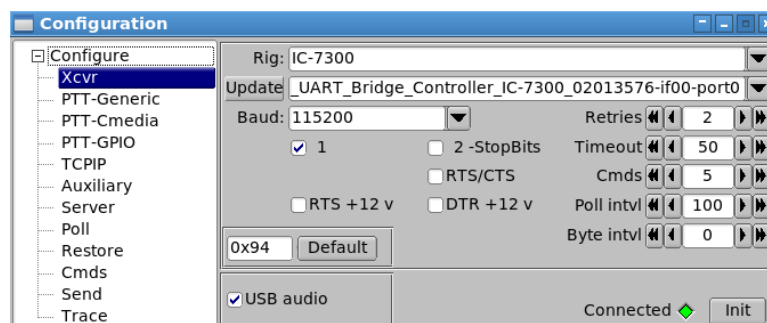

Figure 26.2 Select IC7300



Choose the 7300 from the Rig dropdown list. That will select the default settings which will be good for starters. Note: The RTS +12v and DTR +12v boxes do not need to be selected.

Select the Serial Port to use

- Windows - select the correct COM port
- Mac/Linux - Select the SilconLabs driver from the dropdown list.

If the device does not appear in the list then click the SerPort button to repopulate the list. If it still isn't in the list then the driver is not loading for some reason like the radio is not on or connected or the driver has not been installed properly so that needs to be rectified before going on. If you're using MacOS High Sierra or a later version of MacOS you may need to authorize the driver install in Security & Privacy setup in System Preferences after running the install program. There will be a message on the General page if it has been blocked. Windows

Open the device manager and determine to which com port the serial driver from Silcon Labs is assigned and choose that from the drop down list. Verify that the Baud rate in flrig matches the baud rate selected in the rig. It's better to choose a fixed baud rate than Auto. Now, click the Init button. It should go from red to black lettering. If it does not go to black lettering then verify all of the above again, especially baud rate.

### 26.2.2 Restore xcvr parameters

Select the restore tab

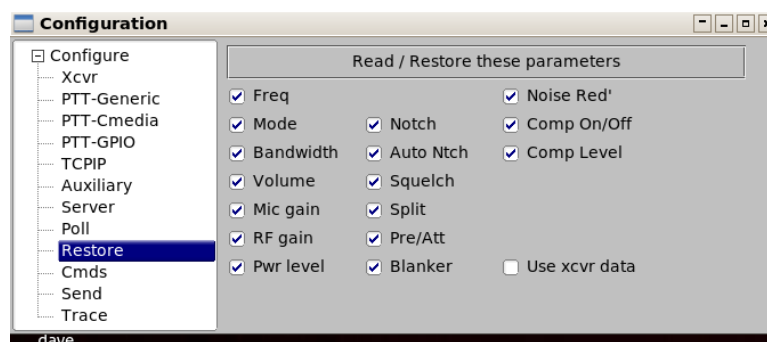

Figure 26.3 Restore IC7300 Settings

and choose whether you want flrig to save and restore all the radio's parameters on startup and exit or whether you want it to open with the same settings as the rig is currently using. If Use xcvr data is checked flrig will start up with the same settings as the rig currently is using.

### 26.2.3 Select the Poll tab

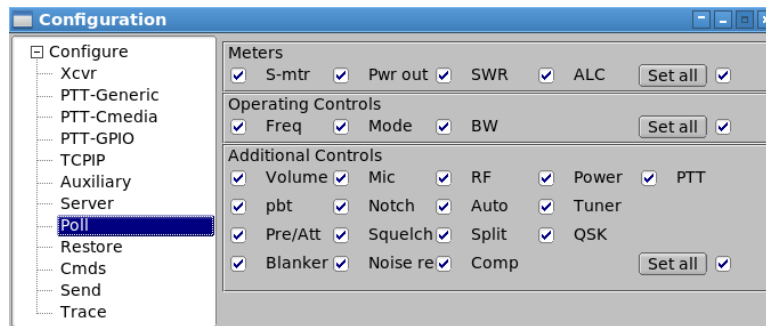

Figure 26.4 IC7300 Polling Settings

and select to poll all of the parameters.

flrig now should have control of the rig so changing frequency in flrig will change the frequency on the rig and vice versa. The buttons and sliders should do as they are labeled.

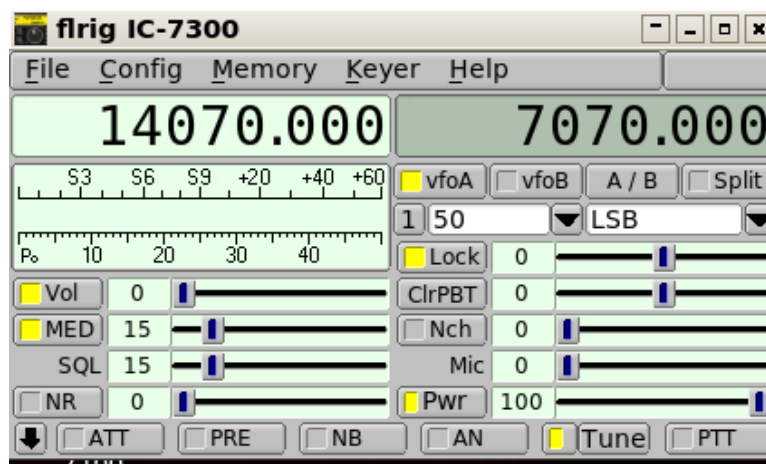

Figure 26.5 IC7300 Main Dialog

I would recommend before you move on that you go to the Config/UI menu and select Tooltips. They are a great help to the new user to figure out what each control does as not all are labeled. You can choose 4 different UI's from the narrow one with small sliders (I use this one – see above screen shot of flrig), to a narrow one with large sliders, to a wide version or a touch version. Now close flrig and restart it to be sure all is well. Everything should be working and you should be able to change frequency on the radio and flrig should follow.

Page Top

[Return to Contents](#)

## Chapter 27

# IC-7600 Setup

Submitted by Andy - VE3NVK / G8VTV

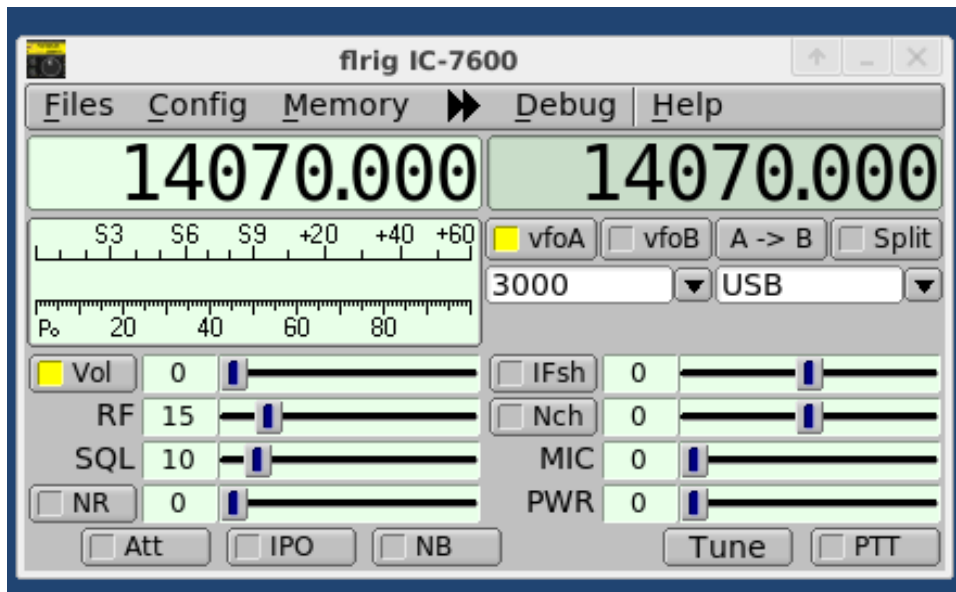

How to use the USB audio connection of the IC-7600 to a computer with FLDIGI and FLRIG.

### 27.1 IC-7600 SETTINGS

Setting the IC7600 menu items

1. Go into setup on the 7600 (Exit/set) then goto "set" and finally "Levels"
2. Scroll to the item "Data 1 mod" and change the setting to USB (by turning the tuning dial).  
If you do not change this setting then the rig will not get the transmit audio - it still sends the received audio signal out though.  
You can use any of Data 1 to Data 3 settings if you have reason to but it is simplest to use the first.
3. Scroll up to the setting for "USB MOD Level" make sure it has some level set (mine is at 40%).

4. Scroll up to "USB Audio SQL" and make sure it is off(open) - We want the software to do any squelching on digital modes.
5. You will probably also want to leave the setting for DATA OFF MOD at the default of "Mic,Acc", if you still intend to use a microphone for SSB!  
You can just turn it to Mic alone to avoid any confusing complications.  
If you have another audio interface plugged into the auxiliary port, such as a TNC you will probably want to leave it alone.

That should be it for the radio settings.

## 27.2 SOFTWARE SETTINGS

Now, on the computer, make sure that the sound card on the output side has some initial level set; try from 20 to 60% for starters.

If using FLRIG, (the companion software) to FLDIGI, both of which I strongly recommend, set a level for microphone and power level (start at say 50%). I find that I ended up with the mic level very low at about 5%. If you are not using FLRIG in association with FLDIGI then you do have some other interface options, explained in the main FLDIGI on-line help.

Start both FLDIGI and FLRIG, make sure that FLDIGI is set to use XML-RPC for rig control, and not anything else. If you try to use rig control from both FLDIGI with FLRIG running then there will be conflicts, and who knows which programme will be in charge. FLDIGI sends frequency, mode and bandwidth changes to the transceiver via FLRIG when XML-RPC is selected. FLRIG in turn annunciates changes back to FLDIGI. The radio, FLRIG and FLDIGI should stay in synch no matter where the change occurs.

### 27.2.1 FLDIGI

1. On FLDIGI's "Configure" tab and rig control tab make sure that you only select XML-RPC.
2. On the "Audio" tab make sure (on Linux) that you have selected the correct audio device. I use PortAudio so I have selected both Capture and Playback show up as "USB Audio CODEC: USB Audio ..." (after that is will show the hardware port as something like (HW:0,0) - this last part will change depending on how your computer is set up to identify the audio ports.
3. In the OS sound mixer application, the 7600 USB audio will probably be identified as "PCM2901 Audio Codec."
4. If you are using Pulse audio the mixer function is performed in the Pulse-audio mixer application. Pulse audio will remember both the record and playback levels required for each application that it serves.

### 27.2.2 FLRIG

1. Open the Config/Transceiver select tab and perform the following in the dialog window that opens
2. Make sure to select the rig ic-7600 that the serial port is selected - it will be something like (again in Linux) /dev/ttyUSB0, the number at the end may be different, and if you have more than one USB serial device connected, make sure you have the correct one. (Hint: use the command, in a terminal screen, 'lsmod')
3. Make sure the CI-V address is correct, the default for the 7600 is 0x7A
4. Check off the "USB Audio" box.

5. Select the button for PTT via CAT.
6. Ensure that the baud rate is compatible with what you have set on the 7600 I use 19200.
7. Select 1 stop bit
8. Enable the checkbox for Echo.
9. Now for retries, retry interval, cmd interval and query interval, I use 2, 50, 5, 100, but other values will certainly work for you. If you want faster response to the frequency when changed using the tune dial on the rig you may want to try reducing the value of QRY interval.

Make sure to press the INIT button before closing the window so that the settings you have changed TAKE.

When using digital modes make sure that (even for CW) that you have selected "USB-D1" for the audio connection. If you use anything else, you will NOT be able to transmit, just receive. (Unless you decided to set up for USB-D2 or D3). This shows in both FLRIG and FLDIGI.

The rig should then also show that it is set to USB-D1 with a blue background just above the frequency display and between the VFO and filter setting indicators.

If, as has happened to me with some of the iterations of FLRIG, the 7600 stops showing USB-D1, change it back by either pressing the USB button repeatedly on the 7600 until it shows, or in FLRIG if you can.

### 27.2.3 SETTING LEVELS AND TUNING

Finally using the TUNE button on FLDIGI, set up the power and modulation levels for almost no ALC action. You will have to play with both the MIC setting in FLRIG, and the output level setting for your sound mixer to get this right. You can work digital modes such as PSK31 very well with power levels of less than 25 watts output. Doing so does not stress your output finals too much and still gives you an effective signal out (unless your antenna system is awful.) At 25 watts output my rig shows about 13 amps for Ip.

When making these level selections make sure you press in and hold the rig's meter button for 1+ sec so that all the readings show at the same time.

Please note that the TUNE button on FLRIG does not work the same as the same as the tune button in FLDIGI. The tune button on FLRIG tells the 7600 to use its internal tuner to match to the antenna at the frequency selected. If you are already tuned then it will go on and off again very quickly with no time to adjust modulation level settings. The TUNE button on FLDIGI sends a continuous two tone signal at the maximum level, and is intended for setting the modulation levels - that is the one to use.

As I only use Linux on my rigs computer I have not been able to provide instructions for Windows users but they are essentially the same except as to how the serial port and audio ports are identified.

#### CAUTION

Last of all, always turn the 7600 on before starting FLRIG and FLDIGI, and always close the two programmes before turning off the 7600. If you do not do it in this fashion you may have to reset settings on starting up the programmes, and they will almost always hang on shutting down - at times necessitating a reboot in Windows.

Page Top

[Return to Contents](#)



## Chapter 28

### TT550 - Pegasus

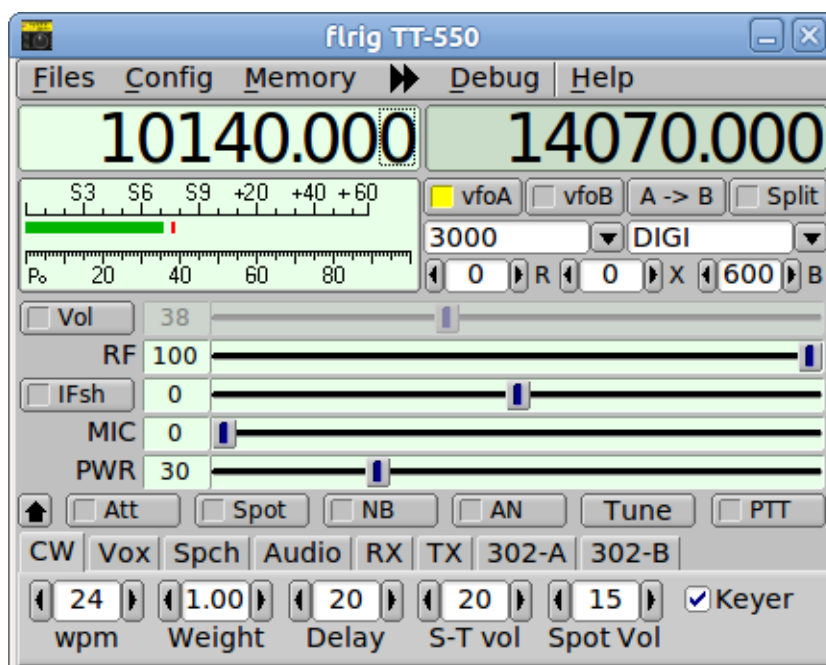

Figure 28.1 FLRIG - TT550

FLRIG provides a full implementation of all TT550 control functions including the operation of the Model 302 remote keypad. The TT550 selection can also be used with the TT538, Jupiter. The Jupiter emulates all of the Pegasus commands.

All of the FLRIG "front panel" controls operate the same as for any other transceiver with a few exceptions. The Pegasus does not have any preamp control. So that button is converted for use as a spot control when the rig is in CW mode.

Select CW mode and then press the spot button. You should hear the sidetone (if not you may need to increase the Spot Vol ... see below). You can then adjust the B (BFO) control for the desired sidetone frequency.

The DIGI mode is unique to FLRIG and the TT550. The control commands available on the Pegasus allow the program to control the center frequency and the bandwidth for all of the DSP filters. The DIGI mode is designed to always place the center frequency of the filter at 1500 Hz. When FLRIG is used with FLDIGI this provides a very convenient and easy way to QSY to a received signal and then narrow down the filter. The Pegasus DSP filters are very well suited to digital mode operations.

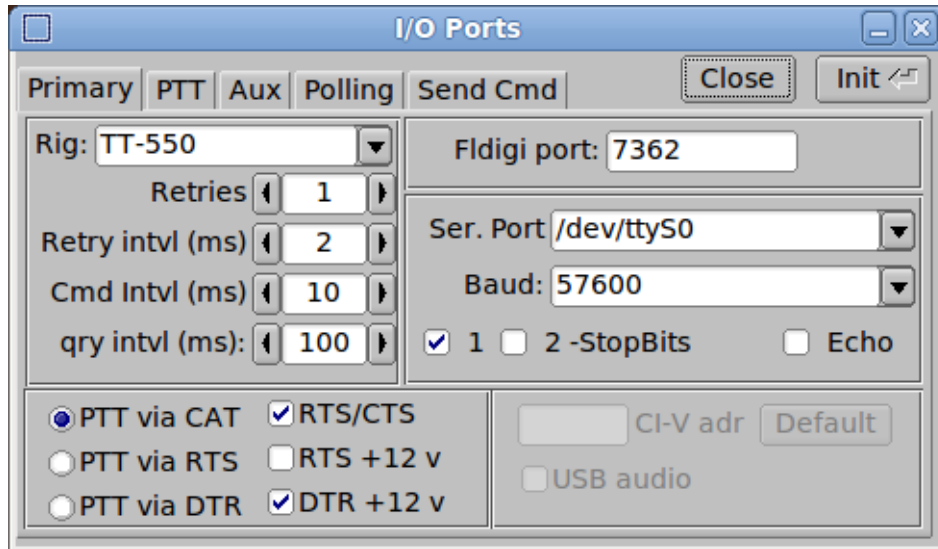

Figure 28.2 I/O Ports - Primary

Selecting the TT550 from the rig selection combo box should preset all of the interface controls. You should only need to select from the serial port combo. FLRIG will find all unused serial ports so be sure that the TT550 is not being accessed by another software when you start FLRIG.

It is necessary to press the Init button when you first set the program for use with a transceiver. Subsequent use should not require any action on the part of the operator.

The TT550 has it's own set up dialog for accessing those controls that are not routinely used. This dialog is opened by the "Config / Xcvr setup" menu.

## 28.1 Additional Control

Access to the additional controls is obtained by the down arrow button to the left of the Att control.

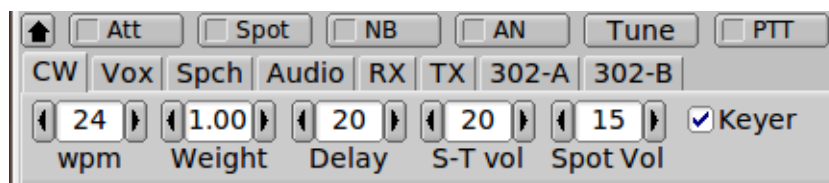

Figure 28.3 TT550 - CW



### 28.1.1 CW

The internal keyer can be enabled and both the words/min and the weight of the keyer can be adjusted. The Pegasus is a QSK rig and you can adjust the QSK hold in milliseconds. You can adjust the keyer sidetone volume relative to the received audio. Set the control to zero if you do not want to hear the sidetone. The Spot Vol control is associated with the Spot button on the front panel. This volume is also relative to the receiver volume control.

### 28.1.2 VOX



Figure 28.4 TT550 - VOX

You can operate the Pegasus with manual SSB PTT or with Vox. The three Vox controls are controlled IAW the 550 manual.

### 28.1.3 Speech

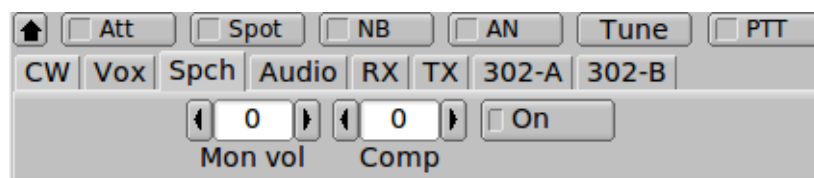

Figure 28.5 TT550 - Speech

You can monitor the SSB speech level (recommended only with headphones). The compression level is also adjustable and speech compression can be enabled or disabled as suited.

The Accessory socket line out level can be set to prevent overdriving of a terminal node controller or computer sound card interface. The front panel NB, noise blanker, control can be set for any level from NONE to

1. AGC can be set for slow, medium or fast. The transmitter can be disabled. Very useful if you do not want idle hands pressing the PTT switch. The Tloop (for amplifier) can be enabled and finally if your Pegasus has the built-in tuner it can be bypassed.

### 28.1.4 Audio

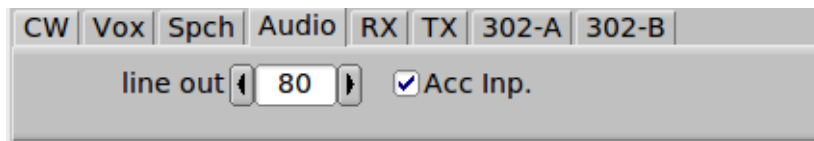

Figure 28.6 TT550 - Audio

Audio can be either from the Mic connector or from the Accessory input (digital mode ops). The level of the line out on the remote connector can be controlled independent of the speaker.

### 28.1.5 RX

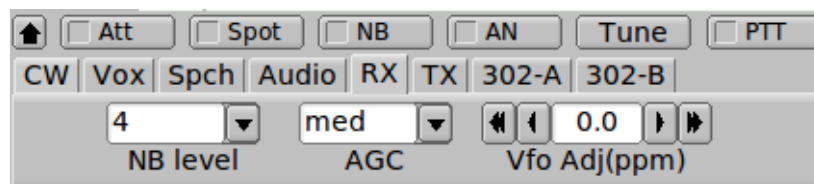

Figure 28.7 TT550 - Receive

The signal frequencies internal to the Pegasus are all derived from a single oscillator. That oscillator can be corrected for frequency error using the VFO adjustment control.

### 28.1.6 TX

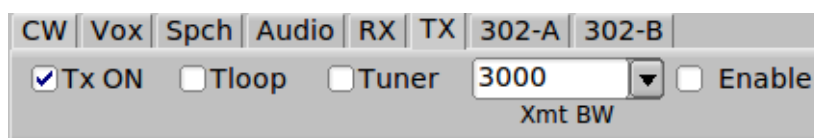

Figure 28.8 TT550 - Transmit

The signal frequencies internal to the Pegasus are all derived from a single oscillator. That oscillator can be corrected for frequency error using the VFO adjustment control.

## 28.1.7 302A

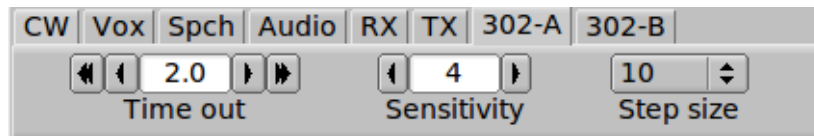
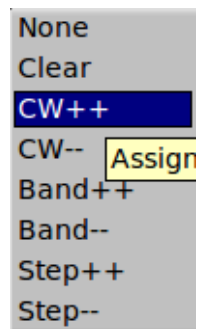

Figure 28.9 TT550 - 302A

302 Keypad Accessory If you have the 302 keypad you can set various parameters to adjust it's performance. The function keys can be assigned on of several response functions:



Both the Pegasus and the Jupiter can be controlled with the Model 302 key pad / encoder.

As you enter keypad values from the keypad they will appear in an entry box at the upper right of the main dialog. These are used for entering a frequency in kHz (i.e. 14.070 MHz is entered as 14070.000). You can abort the input by pressing the decimal value twice in succession.

[Page Top](#)

[Return to Contents](#)



## Chapter 29

# Prefs file contents

A typical transceiver prefs file contains:

```
; FLTK preferences file format 1.0
; vendor: wlhkj.com
; application: IC-7100

[.]

version:1.3.49.06
mainx:526
mainy:24
mainw:735
mainh:150
uisize:0
xcvr_serial_port:/dev/serial/by-id/usb-Silicon_Labs_CP2102_USB_to_UART_Bridge
+_Controller_IC-7100_02010930_A-if00-port0
comm_baudrate:6
comm_stopbits:2
comm_retries:2
comm_wait:50
comm_timeout:50
serloop_timing:200
byte_interval:0
comm_echo:1
ptt_via_cat:1
ptt_via_rts:0
ptt_via_dtr:0
rts_cts_flow:0
rts_plus:1
dtr_plus:1
civadr:0
usbaudio:0
aux_serial_port:NONE
aux_rts:0
aux_dtr:0
sep_serial_port:NONE
sep_rtsptt:0
sep_dtrptt:0
sep_rtsplus:0
set_dtrplus:0
poll_smeter:1
poll_frequency:1
poll_mode:1
poll_bandwidth:1
```

```
poll_volume:4
poll_auto_notch:4
poll_notch:4
poll_ifshift:4
poll_power_control:4
poll_pre_att:4
poll_micgain:4
poll_squelch:4
poll_rfgain:4
poll_pout:1
poll_swr:1
poll_alc:1
poll_split:4
poll_noise:4
poll_nr:4
poll_compression:4
poll_all:1
bw_A:34
mode_A:11
freq_A:7070000
bw_B:34
mode_B:1
freq_B:14100000
filters:1 1 2 1 1 1 2 2 1 1 1 1 1 1 1 1 1 1 1 1 1 1 1 1 1 1 1 1 1 1 1 1 1 1 1 1
bandwidths:-1 -1 -1 -1 -1 -1 -1 -1 -1 -1 -1 -1 -1 -1 -1 -1 -1 -1 -1 -1 -1 -1 -1 -1
+-1 -1 -1 -1 -1 -1 -1 -1
use_rig_data:0
restore_frequency:1
restore_mode:1
restore_bandwidth:1
restore_volume:1
restore_mic_gain:1
restore_rf_gain:1
restore_power_control:1
restore_if_shift:1
restore_notch:1
restore_auto_notch:1
restore_noise:1
restore_squelch:1
restore_split:1
restore_pre_att:1
restore_nr:1
restore_comp_on_off:1
restore_comp_level:1
bool_spkr_on:1
int_volume:13
dbl_power:100
int_mic:50
bool_notch:0
int_notch:0
bool_shift:0
int_shift:0
pbt_lock:0
pbt_inner:0
pbt_outer:0
rfgain:100
squelch:0
no_txqsy:0
schema:0
rx_avg:5
rx_peak:5
pwr_avg:5
pwr_peak:5
```

---

```
pwr_scale:2
digi_sel_on_off:0
digi_sel_val:0
dual_watch:0
ic7610att:6
ft950_rg_reverse:1
line_out:0
data_port:0
vox_on_dataport:1
agc_level:1
cw_wpm:24
cw_weight:3
cw_vol:0
cw_spot:0
spot_onoff:0
cw_spot_tone:600
cw_qsk:15
cw_delay:200
enable_keyer:0
break_in:0
vox_onoff:0
vox_gain:10
vox_anti:10
vox_hang:100
compression:0
compON:0
noise_reduction:0
noise_red_val:4
nb_level:50
bool_noise:0
int_preamp:0
int_att:0
vfo_adj:46
bfo_freq:600
rit_freq:0
xit_freq:0
bpf_center:1500
use_bpf_center:1
label1:cmd 1
command1:
shftcmd1:
label2:cmd 2
command2:
label3:cmd 3
command3:
shftcmd3:
label4:cmd 4
command4:
shftcmd4:
label5:cmd 5
command5:
shftcmd5:
label6:cmd 6
command6:
shftcmd6:
label7:cmd 7
command7:
shftcmd7:
label8:cmd 8
command8:
shftcmd8:
label9:cmd 9
command9:
```

```
shftcmd9:
label10:cmd 10
command10:
shftcmd10:
label11:cmd 11
command11:
shftcmd11:
label12:cmd 12
command12:
shftcmd12:
label13:cmd 13
command13:
shftcmd13:
label14:cmd 14
command14:
shftcmd14:
label15:cmd 15
command15:
shftcmd15:
label16:cmd 16
command16:
shftcmd16:
fg_red:0
fg_green:0
fg_blue:0
bg_red:232
bg_green:255
bg_blue:232
smeter_red:0
smeter_green:180
smeter_blue:0
power_red:180
power_green:0
power_blue:0
swr_red:148
swr_green:0
swr_blue:148
peak_red:255
peak_green:0
peak_blue:0
fg_sys_red:0
fg_sys_green:0
fg_sys_blue:0
bg_sys_red:192
bg_sys_green:192
bg_sys_blue:192
bg2_sys_red:255
bg2_sys_green:255
bg2_sys_blue:255
slider_red:232
slider_green:255
slider_blue:232
slider_btn_red:0
slider_btn_green:0
slider_btn_blue:128
lighted_btn_red:255
lighted_btn_green:255
lighted_btn_blue:0
fontnbr:4
tooltips:0
ui_scheme:gtk+
tcpip_port:4001
tcpip_addr:127.0.0.1
```



---

```
tcpip_ping_delay:50
tcpip_tcpip_reconnect_after:10
tcpip_drops_allowed:10
use_tcpip:0
xcvr_auto_on:0
xcvr_auto_off:0
external_tuner:0
trace:0
rigtrace:0
gettrace:0
settrace:1
debugtrace:0
xmltrace:0
rpctrace:0
startstoptrace:0
rpc_level:0
f160:1805000
m160:6
txT160:0
rxT160:0
offset_160:0
oF_160:600
f80:3580000
m80:6
txT80:0
rxT80:0
offset_80:0
oF_80:600
f40:7070000
m40:6
txT40:0
rxT40:0
offset_40:0
oF_40:600
f30:10140000
m30:6
txT30:0
rxT30:0
offset_30:0
oF_30:600
f20:14070000
m20:6
txT20:0
rxT20:0
offset_20:0
oF_20:600
f17:18100000
m17:6
txT17:0
rxT17:0
offset_17:0
oF_17:600
f15:21070000
m15:6
txT15:0
rxT15:0
offset_15:0
oF_15:600
f12:24920000
m12:6
txT12:0
rxT12:0
offset_12:0
```

```
oF_12:600
f10:28070000
m10:6
txT10:0
rxT10:0
offset_10:0
oF_10:600
f6:50070000
m6:6
txT6:0
rxT_6:0
offset_6:0
oF_6:600
f2:144070000
m2:6
txT2:0
rxT2:0
offset_2:0
oF_2:600
f70:432100000
m70:6
txT70:0
rxT70:0
offset_70:0
oF_70:600
hrd_buttons:1
sliders_button:1
cwioWPM:20
cwioKEYLINE:2
cwioSHARED:0
cwioPORT:
cwioLabel[0]:
cwioMessage[0]:
cwioLabel[1]:
cwioMessage[1]:
cwioLabel[2]:
cwioMessage[2]:
cwioLabel[3]:
cwioMessage[3]:
cwioLabel[4]:
cwioMessage[4]:
cwioLabel[5]:
cwioMessage[5]:
cwioLabel[6]:
cwioMessage[6]:
cwioLabel[7]:
cwioMessage[7]:
cwioLabel[8]:
cwioMessage[8]:
cwioLabel[9]:
cwioMessage[9]:
cwioLabel[10]:
cwioMessage[10]:
cwioLabel[11]:
cwioMessage[11]:
```